



LG

Life's Good

ENGLISH

OWNER'S MANUAL

MONITOR SIGNAGE

Please read this manual carefully before operating the your set and retain it for future reference.

MONITOR SIGNAGE MODELS

72WX70MF

TABLE OF CONTENTS

3 LICENSES

- 31 - DivX® VOD Guide
- 32 - Using PIP/PBP

4 ASSEMBLING AND PREPARING

- 4 Accessories
- 5 Parts and Buttons
- 6 Portrait Layout
- 6 Pemnut Not to be Used

7 REMOTE CONTROL

9 USING THE MONITOR

- 9 Connecting to a PC
- 10 - RGB Connection
- 10 - DVI-D Connection
- 11 - HDMI Connection
- 11 - Display Port Connection
- 12 Adjusting the Screen
- 12 - Selecting an Image Mode
- 12 - Customizing Image Options
- 13 - Customizing PC Display Options
- 13 Adjusting the Sound
- 13 - Selecting an Sound Mode
- 14 - Customizing Sound Options
- 14 Using Additional Options
- 14 - Adjusting Aspect Ratio
- 16 - Using the Input List

17 ENTERTAINMENT

- 17 - Connecting to a Wired Network
- 18 - Network Status
- 19 - Connecting USB Storage Devices
- 20 - Browsing Files
- 21 - Viewing Movies
- 25 - Viewing Photos
- 28 - Listening to Music
- 30 - Viewing the Contents List

34 CUSTOMIZING SETTINGS

- 34 Accessing Main Menus
- 35 - PICTURE Settings
- 38 - AUDIO Settings
- 39 - TIME Settings
- 40 - OPTION Settings
- 45 - NETWORK Settings

46 MAKING CONNECTIONS

- 47 Connecting to a HD receiver, DVD, Camcorder, Camera, Gaming Device or VCR player
- 47 - HDMI Connection
- 47 - Component Connection
- 48 - AV (CVBS) Connection
- 48 Connecting to a USB
- 49 Connecting to the LAN
- 49 - LAN Connection
- 50 Daisy Chain Monitors

51 TROUBLESHOOTING

54 SPECIFICATIONS

57 IR CODES

58 CONTROLLING THE MULTIPLE PRODUCT

- 58 Connecting the Cable
- 58 RS-232C Configurations
- 58 Communication Parameter
- 59 Command Reference List
- 61 Transmission / Receiving Protocol

LICENSES

Supported licenses may differ by model. For more information of the licenses, visit www.lg.com.



The terms HDMI and HDMI High-Definition Multimedia Interface, and the HDMI logo are trademarks or registered trademarks of HDMI Licensing LLC in the United States and other countries.



ABOUT DIVX VIDEO: DivX® is a digital video format created by DivX, LLC, a subsidiary of Rovi Corporation. This is an official DivX Certified® device that plays DivX video. Visit divx.com for more information and software tools to convert your files into DivX videos.

ABOUT DIVX VIDEO-ON-DEMAND: This DivX Certified® device must be registered in order to play purchased DivX Video-on-Demand (VOD) movies. To obtain your registration code, locate the DivX VOD section in your device setup menu. Go to vod.divx.com for more information on how to complete your registration.

DivX Certified® to play DivX® video up to HD 1080p, including premium content.

DivX®, DivX Certified® and associated logos are trademarks of Rovi Corporation or its subsidiaries and are used under license.

Covered by one or more of the following U.S. patents: 7,295,673; 7,460,668; 7,515,710; 7,519,274



Manufactured under license from Dolby Laboratories. Dolby and the double-D symbol are trademarks of Dolby Laboratories.

ASSEMBLING AND PREPARING

Accessories

Check your product box for the following items. If there are any missing accessories, contact the local dealer where you purchased your product. The illustrations in this manual may differ from the actual product and accessories.

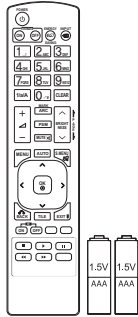

Remote Control and Batteries

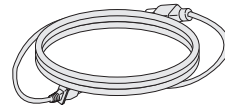

Power Cord

* The power cord may not be provided depending on the region you purchased the product.



CD (Owner's Manual, SuperSign Elite-w, SuperSign Elite-c Program/ SuperSign Manual) / Cards

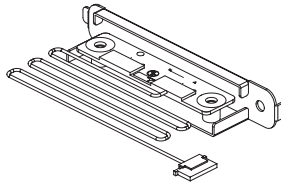

IR Expansion PCB



D-sub 15-Pin Signal Cable



CAUTION

- Do not use any pirated items to ensure the safety and product life span.
- Any damages or injuries by using pirated items are not covered by the warranty.



NOTE

- The accessories supplied with your product may vary depending on the model.
- Product specifications or contents in this manual may be changed without prior notice due to upgrade of product functions.

Parts and Buttons

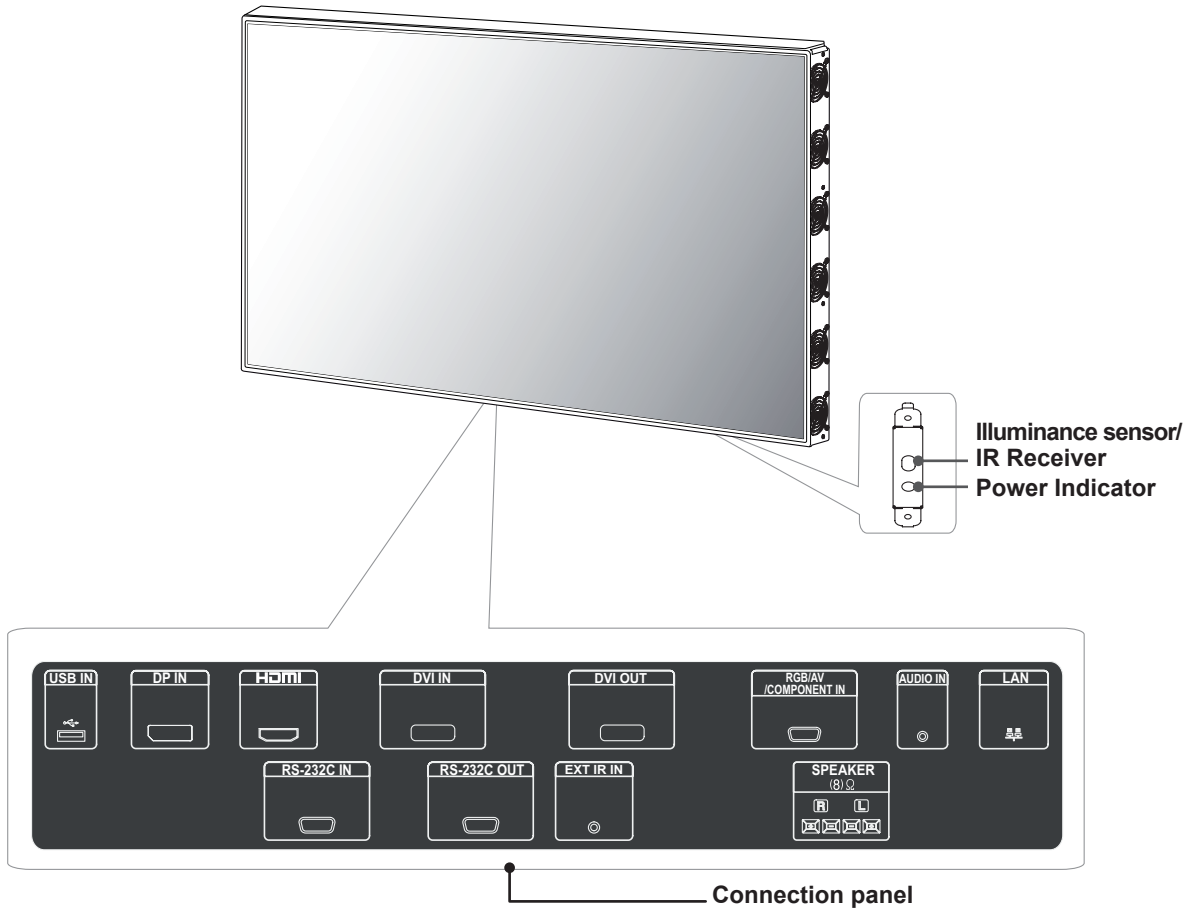

Screen Marks	Description
IR Receiver	This is where the unit receives signals from the remote control.
Power Indicator	This Indicator lights up red when the display operates normally(on mode). If the display In sleep mode (In Power Saving mode), this indicator color changes to amber.
Illuminance sensor	Adjusts the screen brightness by measuring the amount of light.

! NOTE

- You can set the Power indicator to on or off by selecting **OPTION** in the main menu.

Portrait Layout

When installing in a Portrait Layout, rotate the monitor clockwise 90 degrees (when facing the screen).

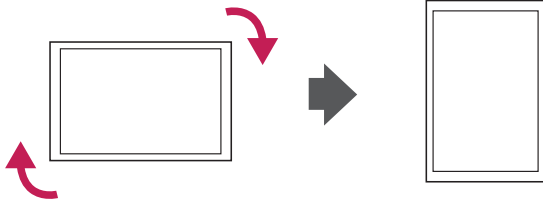

Pemnut Not to be Used

If you use pemnut arbitrarily, the product may be damaged.

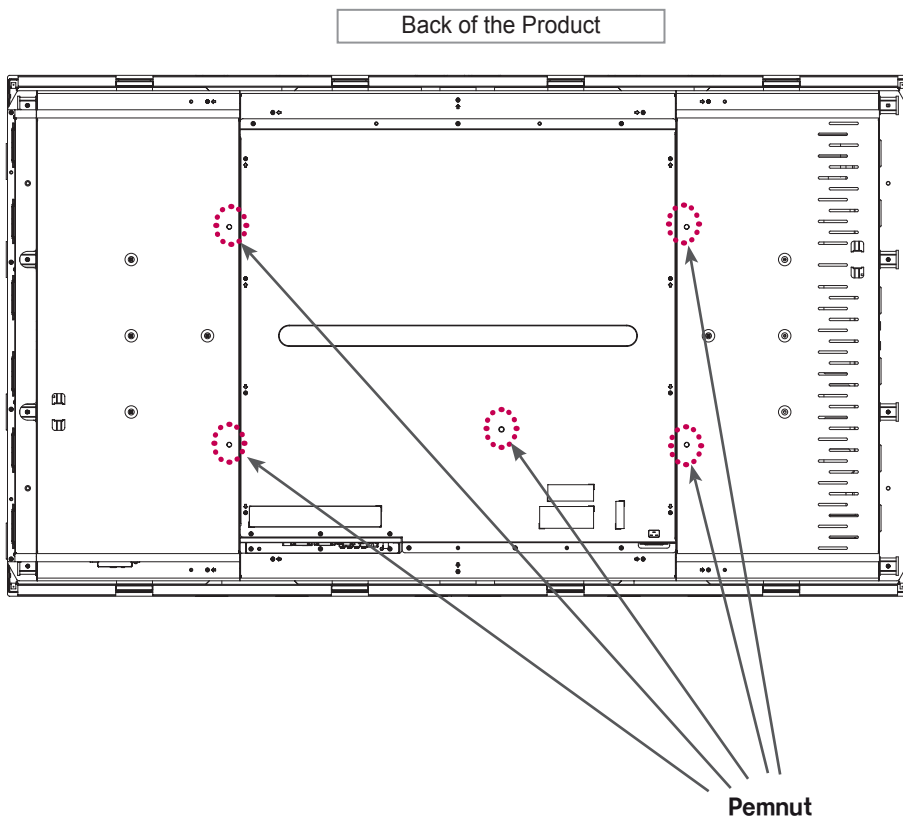

REMOTE CONTROL

The descriptions in this manual are based on the buttons of the remote control. Please read this manual carefully and use the Monitor correctly.

To replace batteries, open the battery cover, replace batteries (1.5 V AAA) matching ⊕ and ⊖ ends to the label inside the compartment, and close the battery cover.

To remove the batteries, perform the installation actions in reverse.



CAUTION

- Do not mix old and new batteries, as this may damage the remote control.
- Make sure to point the remote control at the remote control sensor on the Monitor.

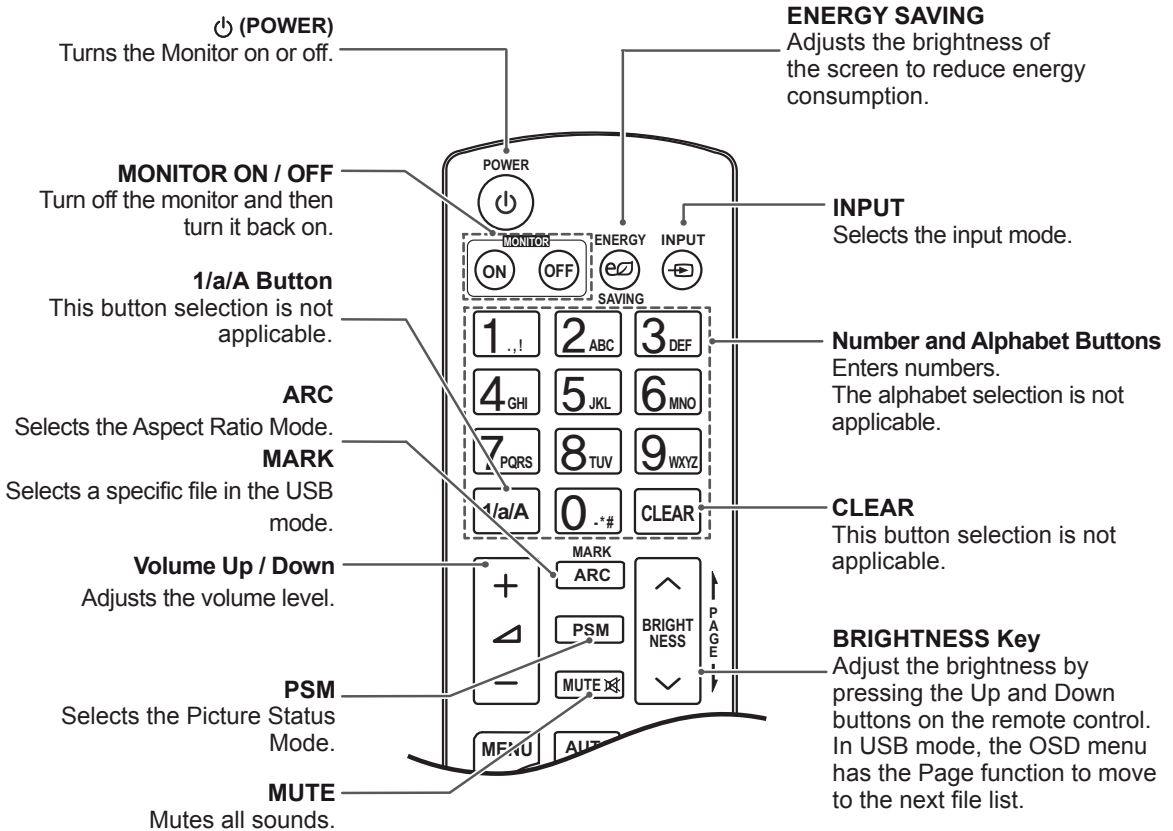
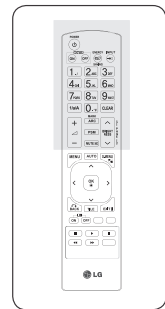
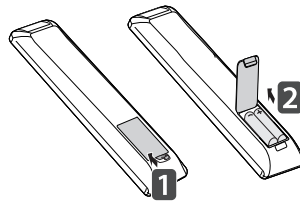

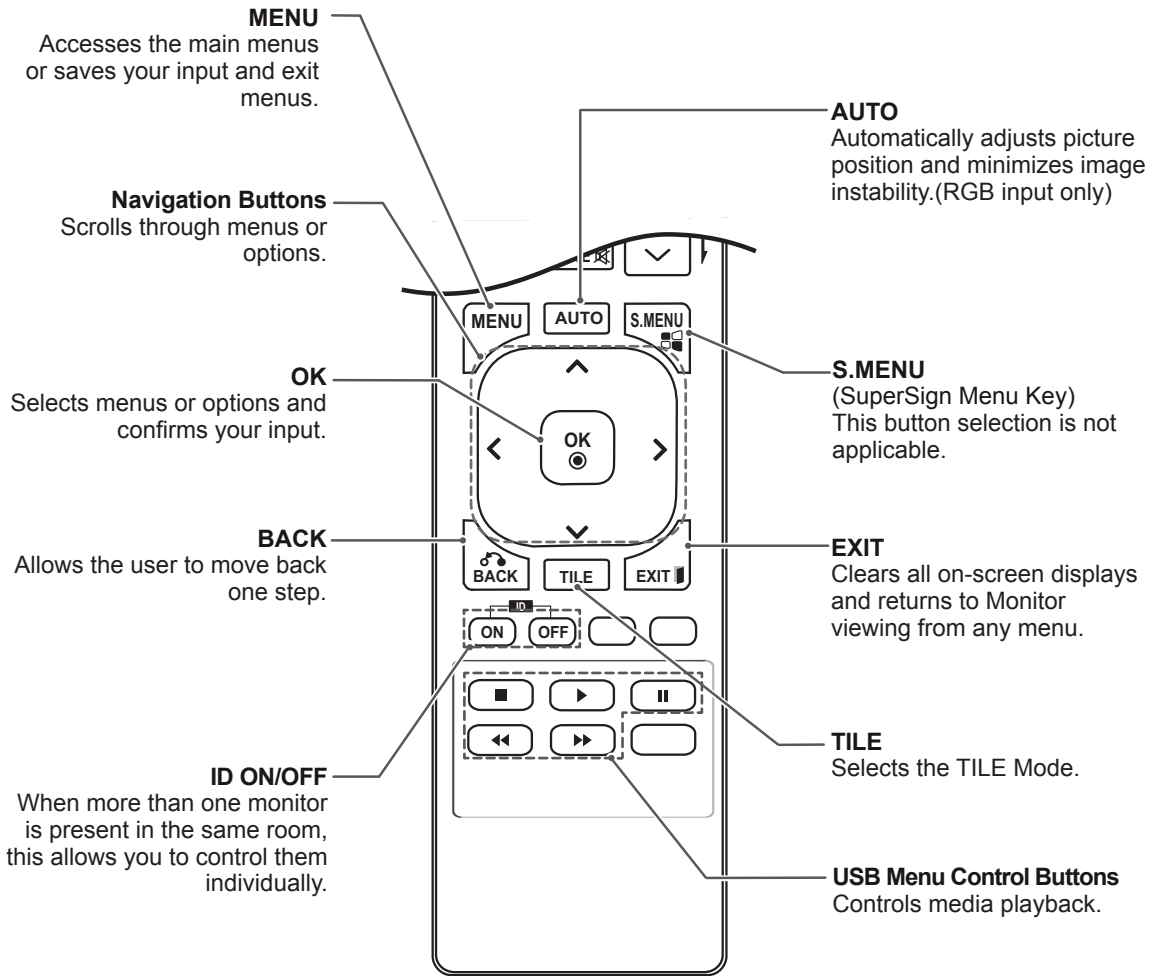
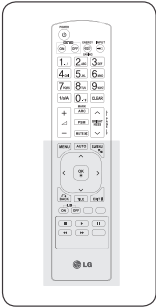

USING THE MONITOR

Connecting to a PC

Your Monitor supports the Plug & Play* feature.

* Plug & Play: This is the function that allows a PC to use the monitor without installing a driver.



CAUTION

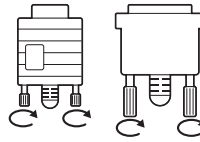

- Connect the signal input cable and tighten it by turning the screws clockwise.
- Do not press the screen with your finger for a long time as this may result in temporary distortion on the screen.
- Avoid displaying a fixed image on the screen for a long period of time to prevent image burn. Use a screensaver if possible.



NOTE

- It is recommended to use the Monitor with the HDMI connection for the best image quality.
- Use a shielded signal interface cable, such as D-sub 15-pin signal cable and DVI cable, with a ferrite core to maintain standard compliance for the product.
- If you turn the monitor on when the set becomes cold, the screen may flicker. This is normal.
- Some red, green, or blue spots may appear on the screen. This is normal.

RGB Connection

Transmits the analog video signal from your PC to the monitor. Connect the PC and the monitor set with the 15-pin signal cable as shown the following illustrations.

Select RGB input source on the monitor.

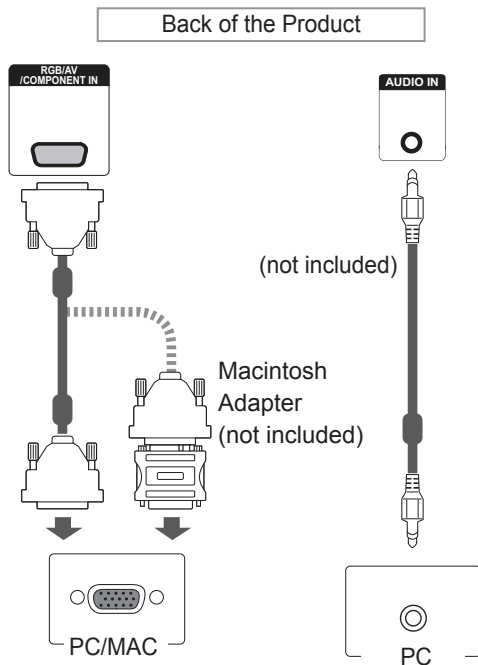

DVI-D Connection

Transmits the digital video signal from your PC to the monitor. Connect the PC and the monitor set with the DVI cable as shown the following illustrations.

Select DVI-D input source on the monitor.

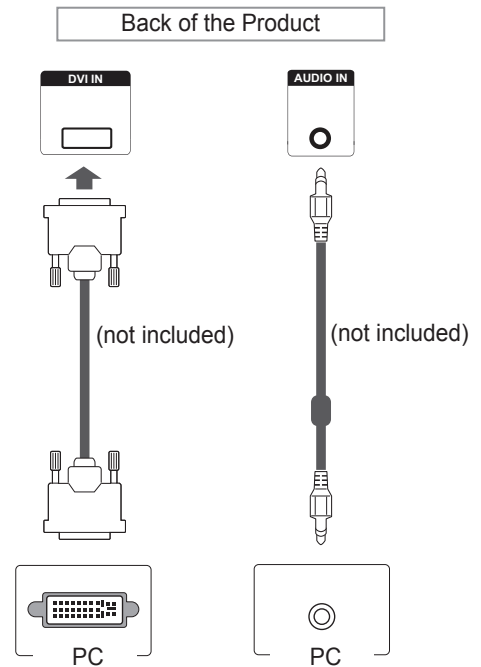

NOTE

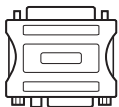

- Use the standard Macintosh adapter since an incompatible adapter is available in the market. (Different signaling system)
- Apple computers may require an adapter to connect to this monitor. Call or visit their web site for more information.

HDMI Connection

Transmits the digital video and audio signals from your PC to the monitor. Connect the PC and the monitor with the HDMI cable as shown in the following illustrations.

Select HDMI input source.

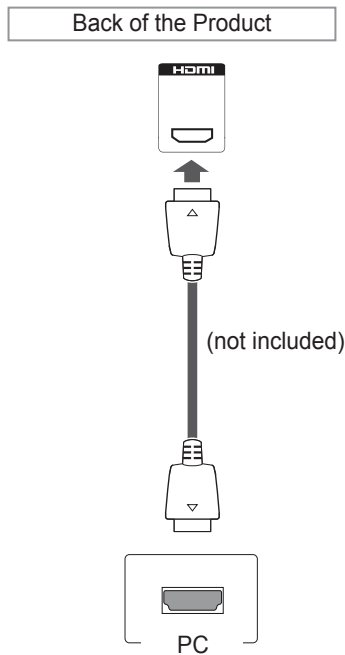

Display Port Connection

Transmits the digital video and audio signals from your PC to the monitor. Connect the PC and the monitor with the Display Port cable as shown in the following illustrations.

Select Display Port input source.

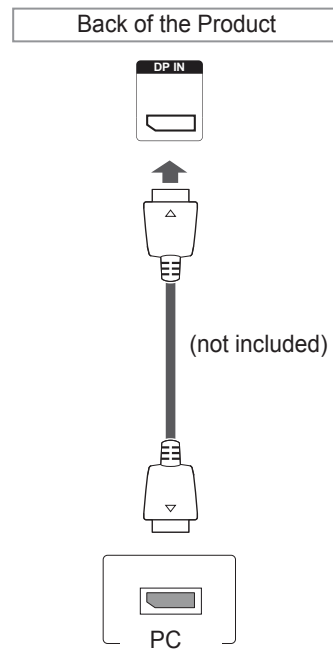

! NOTE

- Use a High Speed HDMI™ Cable.
- Please check the PC environment if you cannot hear the sound in HDMI mode. Some PCs require you to manually change the default audio output to HDMI.
- If you want to use HDMI PC mode, you must set PC/DTV to PC mode.
- When HDMI PC is used, a compatibility problem might occur.

Adjusting the Screen

Selecting an Image Mode

Display images in its optimized settings by selecting one of the preset image modes.

- 1 Press **MENU** to access the main menus.
- 2 Press the navigation buttons to scroll to **PICTURE** and press **OK**.
- 3 Press the navigation buttons to scroll to **Picture Mode** and press **OK**.
- 4 Press the navigation buttons to scroll to an image mode you want and press **OK**.

Mode	Description
Vivid	Adjusts the video image for the retail environment by enhancing the contrast, brightness, color, and sharpness.
Standard	Adjusts the image for a normal environment.
Cinema	Optimizes the video image for a cinematic look to enjoy movies as if you are in a movie theater.
Sport	Optimizes the video image for high and dynamic actions by emphasizing primary colors such as white, grass, or sky blue.
Game	Optimizes the video image for a fast gaming screen such as PCs or games.

- 5 When you are finished, press **EXIT**.
When you return to the previous menu, press **BACK**.

Customizing Image Options

Customize basic and advanced options of each image mode for the best screen performance.

- 1 Press **MENU** to access the main menus.
- 2 Press the navigation buttons to scroll to **PICTURE** and press **OK**.
- 3 Press the navigation buttons to scroll to **Picture Mode** and press **OK**.
- 4 Press the navigation buttons to scroll to an image mode you want and press **OK**.
- 5 Select and adjust the following options, and then press **OK**.

Option	Description
Backlight	Adjusts the brightness of the screen by controlling the LCD backlight. If you decrease the brightness level, the screen becomes darker and the power consumption will be reduced without any video signal loss.
Contrast	Increases or decreases the gradient of the video signal. You may use Contrast when the bright parts of the picture are saturated.
Brightness	Adjusts the base level of the signal in the picture. You may use Brightness when the dark areas of the picture are saturated.
Sharpness	Adjusts the level of crispness in the edges between the light and dark areas of the picture. The lower the level, the softer the image.
Color	Adjusts intensity of all colors.
Tint	Adjusts the balance between red and green levels.
Color Temp.	Set to warm to enhance hotter Colors such as red, or set to cool to make picture bluish.
Advanced Control	Customizes the advanced options. Refer to the Advanced image options.
Picture Reset	Restores the options to the default setting.

- 6 When you are finished, press **EXIT**.
When you return to the previous menu, press **BACK**.

Customizing PC Display Options

Customize options of each image mode for the best image quality.

- This function works in the following mode:
RGB [PC] mode.
- 1 Press **MENU** to access the main menus.
 - 2 Press the navigation buttons to scroll to **PICTURE** and press **OK**.
 - 3 Press the navigation buttons to scroll to **Screen** and press **OK**.
 - 4 Select and adjust following options, and then press **OK**.

Option	Description
Resolution	Selects a proper resolution. See "Customizing PC display options".
Auto Config.	Adjusts the screen position, clock, and phase automatically. The displayed image may be unstable for a few seconds while the configuration is in progress.
Position/ Size/Phase	Adjusts the options when the picture is not clear, especially when characters are shaky. Run Auto Config. before adjusting these.
Reset	Restores the options to the default setting.

- 5 When you are finished, press **EXIT**.
When you return to the previous menu, press **BACK**.

Adjusting the Sound

Selecting an Sound Mode

This Monitor has 5 preset sound modes to compliment different types of video content.

- 1 Press **MENU** to access the main menus.
- 2 Press the navigation buttons to scroll to **AUDIO** and press **OK**.
- 3 Press the navigation buttons to scroll to **Sound Mode** and press **OK**.
- 4 Press the navigation buttons to scroll to a sound mode you want and press **OK**.

Mode	Description
Standard	Select when you want standard-quality sound.
Music	Select when you listen to music.
Cinema	Select when you watch movies.
Sport	Select when you watch sport events.
Game	Selects when you play games.

- 5 When you are finished, press **EXIT**.
When you return to the previous menu, press **BACK**.

Customizing Sound Options

You may customize options of each sound mode for the best sound quality.

- 1 Press **MENU** to access the main menus.
- 2 Press the navigation buttons to scroll to **AUDIO** and press **OK**.
- 3 Press the navigation buttons to scroll to **Sound Mode** and press **OK**.
- 4 Press the navigation buttons to scroll to a sound mode you want and press **OK**.
- 5 Select and adjust following options, and then press **OK**.

Option	Description
Infinite Sound	LG's Infinity Sound option provides 5.1 channel stereo quality sound from two speakers.
Treble	Controls the dominant sounds in the output. When you turn up the treble, it will increase the output of the higher frequency range.
Bass	Controls the softer sounds in the output. When you turn up the bass, it will increase the output of the lower frequency range.
Reset	Resets the sound mode to the default setting.

- 6 When you are finished, press **EXIT**.
When you return to the previous menu, press **BACK**.

Using Additional Options

Adjusting Aspect Ratio

Resize the image to view the image at its optimal size by pressing **ARC** while you are watching content.



CAUTION

- If a fixed image displays on the screen for a long period of time, it will be imprinted and become a permanent disfigurement on the screen. This is image burn or burn-in and not covered by the warranty.
- If the aspect ratio is set to 4:3 for a long period of time, image burn may occur on the letterboxed area of the screen.



NOTE

- You can also change the image size by accessing the main menus.

MODE \ ARC	AV	Component	RGB			Display Port		DVI-D		HDMI	
			PC	DTV	PC	DTV	PC	DTV	PC		
16:9	o	o	o	o	o	o	o	o	o	o	o
Just Scan	x	o	x	o	x	o	x	o	x	o	x
1:1	x	x	o	x	o	x	o	x	o	x	o
4:3	o	o	o	o	o	o	o	o	o	o	o
Zoom	o	o	x	o	x	o	x	o	x	o	x
Cinema Zoom 1	o	o	x	o	x	o	x	o	x	o	x

- **16:9** : This selection will allow you to adjust the picture horizontally, in linear proportion, to fill the entire screen (useful for viewing 4:3 formatted DVDs).

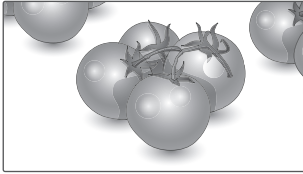

- **4:3** : This selection will allow you to view a picture with an original 4:3 aspect ratio, black bars will appear on both the left and right of the screen.

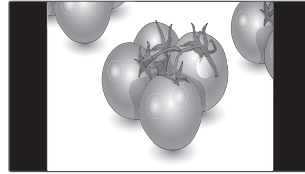

- **Just Scan** : This Selection will allow you view the picture of best quality without loss of original picture in high resolution image.
Note: If there is noise in original picture, You can see the noise at the edge.



- **Zoom** : This selection will allow you to view the picture without any alteration, while filling the entire screen. However, the top and bottom of the picture will be cropped.

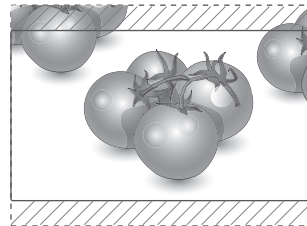

- **1:1** : The aspect ratio is not adjusted from the original. (Only Display Port PC, HDMI PC, DVI-D PC, RGB PC)

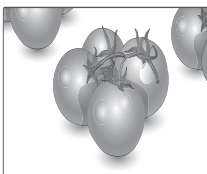

- **Cinema Zoom 1** : Choose Cinema Zoom when you want to enlarge the picture in correct proportion. Note: When enlarging or reducing the picture, the image may become distorted.

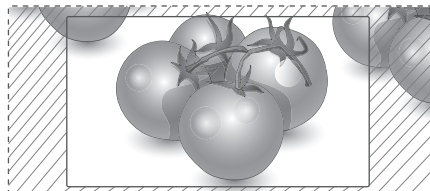

Using the Input List

Selecting an input source

- 1 Press **INPUT** to access the input source list.
 - The connected device displays on each input source.
- 2 Press the Navigation buttons to scroll to one of the input sources and press **OK**.

Input source	Description
AV	Watch video from a VCR or other external devices.
Component	Watch content from a DVD or other external devices, or through a digital set-top box.
RGB	View a PC display on the screen.
Display Port	Watch content from a PC, DVD of Digital set-top box other high definition devices.
DVI-D	View a PC display on the screen.
HDMI	Watch content from a PC, DVD of Digital set-top box other high definition devices.

ENTERTAINMENT

Connecting to a Wired Network

(Depending on model)

Connect the display to a local area network (LAN) via the LAN port as shown on the following illustration and set up the network settings.

This monitor only supports a wired network connection.

After making a physical connection, a small number of home networks may require the display network settings to be adjusted. For most home networks, the display will connect to automatically without any adjustments.

For detail information, contact your internet provider or router manual.

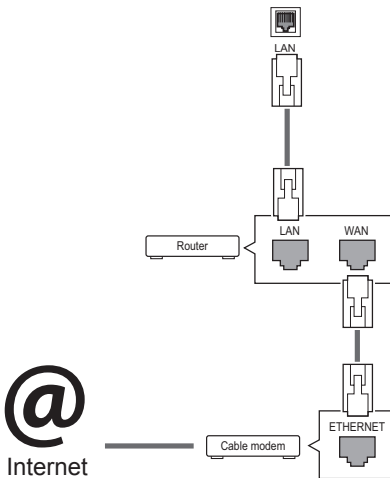

To set up the network settings: (Even if your display has already connected automatically, running setup again will not harm anything),

- 1 Press **MENU** to access the main menus.
- 2 Press the navigation buttons to scroll to **NETWORK** and press **OK**.
- 3 Press the navigation buttons to select **Network Setting** and press **OK**.
- 4 If you already set network setting, select **Resetting**. The new connection settings resets the current network settings.
- 5 Select **IP Auto Setting** or **IP Manual Setting**.
 - If selecting **IP Manual Setting**, press the Navigation and Number buttons. IP addresses will need to be input manually.
 - **IP Auto Setting**: Select this if there is a DHCP server (Router) on the local area network (LAN) via wired connection, the display will automatically be allocated an IP address. If you're using a broadband router or broadband modem that has a DHCP (Dynamic Host Configuration Protocol) server function. The IP address will automatically be determined.
- 6 When you are finished, press **EXIT**.

! CAUTION

- Do not connect a modular phone cable to the LAN port.
- Since there are various connection methods, please follow the specifications of your telecommunication carrier or internet service provider.

! CAUTION

- Network setting menu will not be available until the display is connected to physical network.
- Since there are various connection methods, please follow the specifications of your telecommunication carrier or internet service provider.

! NOTE

- If you want to access the Internet directly on your display, the internet connection should always be on.
- If you cannot access the Internet, check the network conditions from a PC on your network.
- When you use **Network Setting**, check the LAN cable or check if DHCP in the router is turned on.
- If you do not complete the network settings, the network may not work properly.

Tips for Network setting

- Use a standard LAN cable with this display. Cat5 or better with a RJ45 connector.
- Many network connection problems during set up can often be fixed by re-setting the router or modem. After connecting the display to the home network, quickly power off and/or disconnect the power cable of the home network router or cable modem. Then power on and/or connect the power cable again.
- Depending on the internet service provider (ISP), the number of devices that can receive internet service may be limited by the applicable terms of service. For details, contact your ISP.
- LG is not responsible for any malfunction of the display and/or the internet connection feature due to communication errors/malfunctions associated with your internet connection, or other connected equipment.
- LG is not responsible for problems within your internet connection.
- You may experience undesired results if the network connection speed does not meet the requirements of the content being accessed.
- Some internet connection operations may not be possible due to certain restrictions set by the Internet service provider (ISP) supplying your Internet connection.
- Any fees charged by an ISP including, without limitation, connection charges are your responsibility.

- A 10 Base-T or 100 Base-TX LAN port is required when using a wired connection to this display. If your internet service does not allow for such a connection, you will not be able to connect the display.
- A DSL modem is required to use DSL service and a cable modem is required to use cable modem service. Depending on the access method of and subscriber agreement with your ISP, you may not be able to use the internet connection feature contained in this display or you may be limited to the number of devices you can connect at the same time. (If your ISP limits subscription to one device, this display may not be allowed to connect when a PC is already connected.)
- The use of a Router may not be allowed or its usage may be limited depending on the policies and restrictions of your ISP. For details, contact your ISP directly.

Network Status

- 1 Press **MENU** to access the main menus.
- 2 Press the navigation buttons to scroll to **NETWORK** and press **OK**.
- 3 Press the navigation buttons to select **Network Status**.
- 4 Press **OK** to check the network status.
- 5 When you are finished, press **EXIT**.

Option	Description
Setting	Return to the network setting menu.
Test	Test the current network status after setting the network.
Close	Return to the previous menu.

Connecting USB Storage Devices

You can connect USB storage devices such as a USB flash memory, external hard drive to the display and use multimedia features .

Connect a USB flash memory or USB memory card reader to the Display as shown on the following illustration. The My media screen appears.

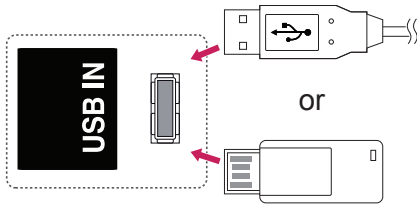

CAUTION

- Do not turn the display off or remove a USB storage device while the EMF (my media) Menu is activated, as this could result in loss of files or damage to the USB storage device.
- Back up your files saved on a USB storage device frequently, as you may lose or damage the files and this may be not covered by the warranty.

Tips for using USB storage devices

- Only a USB storage device is recognizable.
- If the USB storage device is connected through a USB hub, the device is not recognizable.
- A USB storage device using an automatic recognition program may not be recognized.
- A USB storage device which uses its own driver may not be recognized.
- The recognition speed of a USB storage device may depend on each device.
- Please do not turn off the display or unplug the USB device when the connected USB storage device is working. When such device is suddenly separated or unplugged, the stored files or the USB storage device may be damaged.
- Please do not connect the USB storage device which was artificially maneuvered on the PC. The device may cause the product to malfunction or fail to be played. Never forget to use only a USB storage device which has normal music files, image files, or movie files.
- Please use only a USB storage device which was formatted as a FAT32 file system or NTFS file system provided with the Windows operating system. In case of a storage device formatted as a different utility program which is not supported by Windows, it may not be recognized.
- Please connect power to a USB storage device(over 0.5 A) which requires an external power supply. If not, the device may not be recognized.
- Please connect a USB storage device with the cable offered by the device maker.
- Some USB storage devices may not be supported or operated smoothly.
- File alignment method of USB storage device is similar to Window XP and filename can recognize up to 100 English characters.
- Be sure to back up important files since data stored in a USB memory device may be damaged. We will not be responsible for any data loss.

- If the USB HDD does not have an external power source, the USB device may not be detected. So be sure to connect the external power source.
 - Please use a power adaptor for an external power source. We do not guarantee an USB cable for an external power source.
- If your USB memory device has multiple partitions, or if you use a USB multi-card reader, you can use up to 4 partitions or USB memory devices.
- If a USB memory device is connected to a USB multi-card reader, its volume data may not be detected.
- If the USB memory device does not work properly, disconnect and reconnect it.
- How fast a USB memory device is detected differs from device to device.
- If the USB is connected in Standby Mode, specific hard disk will automatically be loaded when the display is turned on.
- The recommended capacity is 1 TB or less for a USB external hard disk and 32 GB or less for USB memory.
- Any device with more than the recommended capacity may not work properly.
- If a USB external hard disk with a Energy Saving function does not work, turn the hard disk off and on again to make it work properly.
- USB storage devices below USB 2.0 are supported as well. But they may not work properly in the movie list.
- Maximum of 999 folders or files can be recognized under one folder.
- It is recommended to use a certified USB storage device and cable. Otherwise, a USB storage device may not be detected or a playback error may occur.
- Only a USB memory stick can be used to play back the files distributed and stored by SuperSign Manager. A USB hard disk or multi-card reader will not work.
- Only an FAT 32 file formatted storage device can play back the files distributed and stored by SuperSign manager.
- A USB 3.0 storage device may not work.

Browsing Files

Access the photo, music, or movie lists and browse files.

- 1 Connect a USB storage device.
- 2 Press **MENU** to access the main menus.
- 3 Press the navigation buttons to scroll to **My Media** and press **OK**.
- 4 Press the navigation buttons to choose from **Movie List**, **Photo List**, **Music List**, or **Contents List** and press **OK**.

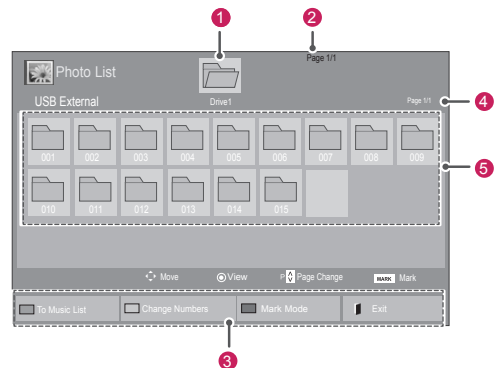
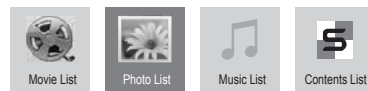

No.	Description
1	Moves to upper level folder
2	Current page/Total pages
3	Corresponding buttons on the remote control
4	Current page/ total pages of contents under the folder focused on 1
5	Contents under the folder focused on 1
Button	Description
Green Button	Repeatedly, press the GREEN button to converted to Movie List->Photo List, Photo List->Music List, Music List->Contents List or Contents List->Movie List .
Yellow Button	A method to view in 5 large thumbnail or simple list.
Blue Button	Convert to Mark Mode.

Supported File Formats

Type	Supported file format
Movie	<p>DAT,MPG,MPEG,VOB,AVI,DivX,MP4,MKV,TS,TRP,TP,ASF,WMV,FLV)</p> <p>Movie(* .mpg/* .mpeg/* .dat/* .ts/* .trp/* .tp/* .vob/* .mp4/* .mov/* .mkv/* .divx/* .avi/* .asf/* .wmv/* .flv/* .avi(motion-jpeg)/* .</p> <p>mp4(motion-jpeg)/* .mkv(motion-jpeg))supporting file</p> <p>Video format : DivX 3.11, DivX4, DivX5, DivX6, Xvid1.00, Xvid1.01, Xvid1.02, Xvid1.03, Xvid1.10 beta-1/beta-2,</p> <p>Mpeg-1, Mpeg-2, Mpeg-4, H.264/AVC, VC1, JPEG, Sorenson H.263</p> <p>Audio format : Dolby Digital, AAC, Mpeg, MP3, LPCM, HE-AAC, ADPCM, WMA</p> <p>Bit rate : within 32 kbps to 320 kbps(MP3)</p> <p>External Subtitle format : *.smi/* .srt/* .sub (MicroDVD, Subviewer1.0/2.0)/* .ass/* .ssa/* .txt(TMPlayer)/* .psb(PowerDivX)</p> <p>Internal Subtitle format : only, XSUB (It is the subtitle format used in DivX6 files)</p>
Photo	<p>JPEG</p> <p>Baseline : 64 x 64 to 15360 x 8640</p> <p>Progressive : 64 x 64 to 1920 x 1440</p> <ul style="list-style-type: none"> You can play JPEG files only. Non-supported files are displayed in the form of predefined icon.
Music	<p>MP3</p> <p>Bit rate 32 to 320</p> <ul style="list-style-type: none"> Sampling rate MPEG1 Layer3 : 32 kHz, 44.1 kHz, 48 kHz Sampling rate MPEG2 Layer3 : 16 kHz, 22.05 kHz, 24 kHz Sampling rate MPEG2.5 Layer3 : 8 kHz, 11.025 kHz, 12 kHz
Content (when using SuperSign Manager)	<p>File Extensions : *.cts/ *.cse</p> <p>Movie</p> <p>File Extensions: *.mpg/* .mpeg/* .dat/* .ts/* .trp/* .tp/* .vob/* .mp4/* .mov/* .mkv/* .avi/* .asf/* .wmv/* .avi(motion JPEG)/* .mp4(motion JPEG)/* .mkv(motion JPEG)</p> <p>Video format: MPEG1, MPEG2, MPEG4, H.264/AVC, DivX 3.11, DivX4, DivX5, DivX6, Xvid 1.00, Xvid 1.01, Xvid 1.02, Xvid 1.03, Xwvid 1.10-beta1/2, JPEG, VC1(WVC1/WMV3)</p> <p>Audio format: MP2, MP3, Dolby Digital, LPCM, AAC, HE-AAC, LPCM, ADPCM, WMA, MP3</p>

	File Extensions	Item	Profile
Photo	JPEG JPG PNG BMP	supported file format	<ul style="list-style-type: none"> SOF0: baseline SOF1: Extend Sequential SOF2: Progressive
		Photo size	<ul style="list-style-type: none"> Min: 64 x 64 Max Type: 1366 x 768
Music	MP3	Bit rate	32 kbps to 320 kbps
		Sampling rate	32 kHz, 44.1 kHz, 48 kHz (MPEG1 L3) 16 kHz, 22.05 kHz, 24 kHz (MPEG2 L3) 8kHz, 11.025 kHz, 12 kHz (MPEG2.5 L3)

Viewing Movies

Play video files on display. Your display shows all of the video files saved in a USB storage device or shared folder on a PC.

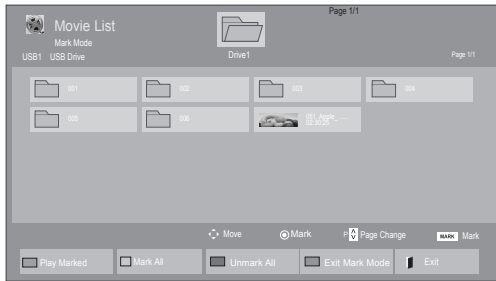
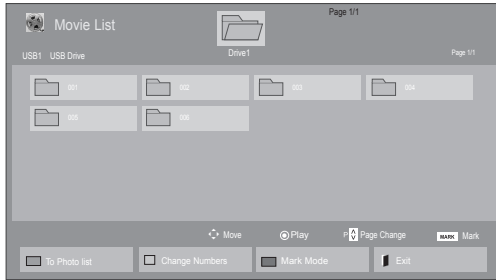

- 1 Press the navigation buttons to scroll to **My Media** and press **OK**.
- 2 Press the navigation buttons to scroll to **Movie List** and press **OK**.
- 3 Press the navigation buttons to scroll to a folder you want and press **OK**.
- 4 Press the navigation buttons to scroll to a file you want and press **OK**.



Menu	Description
Play Marked	Play the selected movie file. Once a movie file finishes playing, the next selected one will be played automatically.
Mark All	Mark all movie files on the screen.
Unmark All	Deselect all marked movie files.
Exit Mark Mode	Exit the Mark Mode.









5 Play a movie.

NOTE

- Non-supported files are displayed the preview image by icon only .
- Abnormal files are displayed in the form of bitmap .

6 Control playback by using the following buttons.



Button	Description
	Stops the playback
	Plays a video
	Pauses or resumes the playback
	Scans backward in a file
	Scans forward in a file
	Show the Option menu.
	Hide the menu on the full-sized screen.
	Return to Movie List .
"<" or ">"	Skips to specific points in a file during playback. The time of a specific point will appear on the status bar. In some files, this function may not work properly.
ENERGY SAVING 	Press the ENERGY SAVING button repeatedly to increase the brightness of your screen.

Tips for Using Playing Video Files

- Some user-created subtitles may not work properly.
- Some special characters are not supported in subtitles.
- HTML tags are not supported in subtitles.
- Subtitles in languages other than the supported languages are not available.
- The screen may suffer temporary interruptions (image stoppage, faster playback, etc.) when the audio language is changed.
- A damaged movie file may not be played correctly, or some player functions may not be usable.
- Movie files produced with some encoders may not be played correctly.
- If the video and audio structure of recorded file is not interleaved, either video or audio is outputted.
- HD videos with a maximum of 1920x1080@25/30P or 1280x720@50/60P are supported, depending on the frame.
- Videos with resolutions higher than 1920x1080@25/30P or 1280x720@50/60P may not work properly depending on the frame.
- Movie files other than the specified types and formats may not work properly.
- Max bitrate of playable movie file is 20 Mbps. (only, Motion JPEG : 10 Mbps)
- We do not guarantee smooth playback of profiles encoded level 4.1 or higher in H.264/AVC.
- DTS Audio codec is not supported.
- A movie file more than 30 GB in file size is not supported for playback.
- A DivX movie file and its subtitle file must be located in the same folder.
- A video file name and its subtitle file name must be identical for it to be displayed.
- Playing a video via a USB connection that doesn't support high speed may not work properly.
- Files encoded with GMC (Global Motion Compensation) may not be played.

- When you are watching the movie by Movie List function, you can adjust an image by Energy Saving key on the remote control. User setup for each image mode does not operate.

Video Options

- 1 Press **MENU** to access the **Pop-Up** menus.
- 2 Press the Navigation buttons to scroll to **Set Video Play.**, **Set Video.** or **Set Audio.** and press **OK**.

NOTE

- Option values changed in **Movie List** does not affect **Photo List** and **Music List**.
- Option value changed in **Photo List** and **Music List** are changed likewise in **Photo List** and **Music List** excluding **Movie List**.
- When replaying the video file after stopping, you can play from where it stopped previously.

When you select the **Set Video Play**,

- 1 Press the Navigation buttons to scroll to show the **Picture Size, Audio Language, Subtitle Language, or Repeat**.
- 2 Press the navigation buttons to scroll to make appropriate adjustments.

Menu	Description
Picture Size	Selects your desired picture format during movie play.
Audio Language	Changes the Language Group of the audio during movie play. Files with a single audio track cannot be selected.
Subtitle Language	Turn on/off the subtitle.
Language	Activated for SMI subtitle and can select the language within the subtitle.
Code Page	Can select the font for subtitle. When set to default, same font as general menu will be used.
Sync	Adjusts the time synchronization of the subtitle from -10 secs to +10 secs by steps of 0.5 secs during movie play.
Position	Changes the position of the subtitle either up or down during movie play.
Size	Selects your desired Subtitle size during movie play.
Repeat	Turn on/off repeat function of movie playback. When turned on, the file within the folder will be played back repeatedly. Even when the repeated playback is turned off, it can run the playback if the file name is similar to the previous file.

Code Page	Support Language
Latin1	English, Spanish, French, German, Italian, Swedish, Finnish, Dutch, Portuguese, Danish, Romanian, Norwegian, Albanian, Gaelic, Welsh, Irish, Catalan, Valencian
Latin2	Bosnian, Polish, Croatian, Czech, Slovak, Slovenian, Serbian, Hungarian
Latin4	Estonian, Latvian, Lithuanian
Cyrillic	Bulgarian, Macedonian, Russian, Ukrainian, Kazakh
Greek	Greek
Korean	Korean

 **NOTE**

- Only 10,000 of sync blocks can be supported within the subtitle file.
- When playing a video, you can adjust the picture size by pressing the ARC button.
- Subtitles in your language are only supported when the OSD menu is also in this language.
- The code page options may be disabled depending on the language of the subtitle files.
- Select the appropriate code page for the subtitle files.

When you select the **Set Video**,

- 1 Press the navigation buttons to scroll to make appropriate adjustments.

When you select the **Set Audio**,

- 1 Press the navigation buttons to scroll to show the **Sound Mode**, **Clear Voice II** or **Balance**.
- 2 Press the navigation buttons to scroll to make appropriate adjustments.

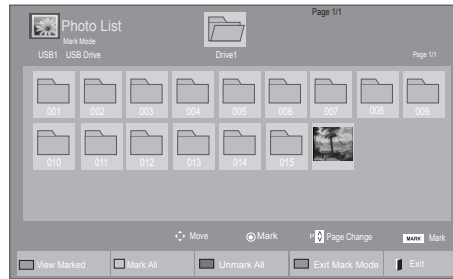
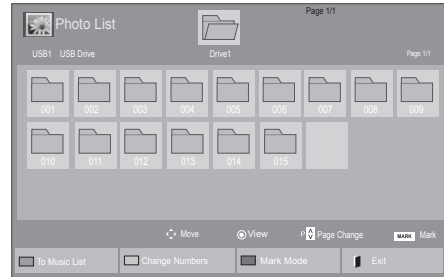

Viewing Photos

View image files saved in a USB storage device. The displays on the screen may differ from the model.

- 1 Press the navigation buttons to scroll to **My Media** and press **OK**.
- 2 Press the navigation buttons to scroll to **Photo List** and press **OK**.
- 3 Press the navigation buttons to scroll to a folder you want and press **OK**.
- 4 Press the navigation buttons to scroll to a file you want and press **OK**.

Menu	Description
View Marked	Display the selected photo file.
Mark All	Mark all photo files on the screen.
Unmark All	Deselect all marked photo files.
Exit Mark Mode	Exit the Mark Mode.

- 5 View photos.

NOTE

- Non-supported files are displayed the pre-view image by icon only ⚠.
- Abnormal files are displayed in the form of bitmap ❌.

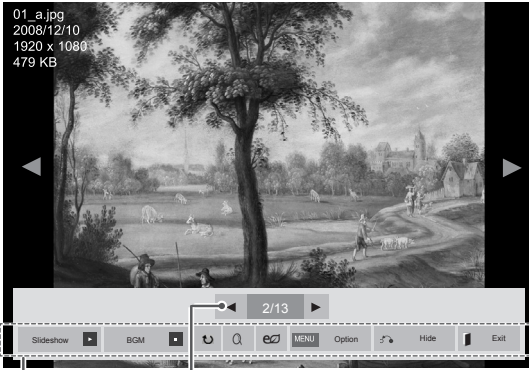

Using Photo Options

Use the following options while viewing photos.



Options

Number of selected photos

Option	Description
Slideshow	Starts or stops a slideshow with selected photos. If there are no selected photos, all photos saved in the current folder display during a slideshow. Select Option to set the speed and view mode of the slideshow.
BGM	Turns the background music on or off. To set the background music folder, select Option . You can adjust Option by MENU button on the remote control.
	Rotates photos clockwise (90°, 180°, 270°, 360°). NOTE <ul style="list-style-type: none"> The supported photo size is limited. You cannot rotate a photo if the resolution of the rotated width is larger than the supported resolution size.
	Enlarges the image to 200% or 400%. NOTE <ul style="list-style-type: none"> Zoom to 200% or 400% only work for image of 1372×772 pixel size or larger. For image of 960×540 pixel size or larger, only zoom to 400% works properly.



ENERGY SAVING 	Press the ENERGY SAVING button repeatedly to change the brightness of your screen.
MENU	<ul style="list-style-type: none"> Slide Speed: Selects a slideshow speed (Fast, Medium, Slow). TransitionEffect: Set the view mode of the slideshow. BGM: Selects a music folder for the background music. NOTE <ul style="list-style-type: none"> You cannot change the music folder while the background music is playing. You can only select the MP3 folder saved on the device that currently displays the photo.
	Hides the option window. To display the options, press OK .
	Return to Photo List .

Photo Options





- 1 Press **MENU** to show the **Option** menus.
- 2 Press the Navigation buttons to scroll to **Set Photo View**, **Set Video**, or **Set Audio**, and press **OK**.

NOTE	<ul style="list-style-type: none"> Option values changed in Movie List does not affect Photo List and Music List. Option value changed in Photo List and Music List are changed likewise in Photo List and Music List excluding Movie List.
-------------	---

When you select the **Set Photo View**,

- 1 Press the Navigation buttons to scroll to select **Slide Speed, Transition Effect**, or **BGM**.
- 2 Press the Navigation buttons to scroll to make appropriate adjustments.

Transition Effect Option

Option	Description
Sliding	Pushes the current slide out of view as it plays to the next slide. 
Stairs	Pushes the current slide in a staircase shape as it plays to the next slide. 
Door Open /Close	Pushes the current slide like opening or closing the door as it plays to the next slide. 
Shutter	Pushes the current slide like drawing or pulling down the blind as it plays to the next slide. 
Fade In	Fades the slide out slowly before playing to the next slide. 

When you select the **Set Video**,

- 1 Press the navigation buttons to scroll to make appropriate adjustments.

When you select the **Set Audio**,

- 1 Press the navigation buttons to scroll to show the **Sound Mode**, **Clear Voice II** or **Balance**.
- 2 Press the navigation buttons to scroll to make appropriate adjustments.

Listening to Music

- 1 Press the navigation buttons to scroll to **My Media** and press **OK**.
- 2 Press the navigation buttons to scroll to **Music List** and press **OK**.
- 3 Press the navigation buttons to scroll to a folder you want and press **OK**.
- 4 Press the navigation buttons to scroll to a file you want and press **OK**.

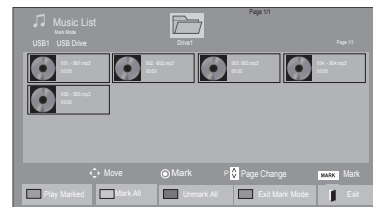
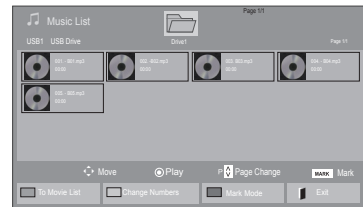

Menu	Description
Play Marked	Display the selected music file.
Mark All	Mark all music files on the screen.
Unmark All	Deselect all marked music files.
Exit Mark Mode	Exit the Mark Mode.

- 5 Play music.

6 Control playback by using the following buttons.



Button	Description
	Stops playback
	Plays a music file
	Pauses or resumes playback
	Skips to the next file
	Skips to the previous file
	When playing, When you press the button, the previous music file will be played. When you press the button, the next music file will be played.
Green Button	Start playing the selected music files and then move to the Photo List .
ENERGY SAVING 	Press the ENERGY SAVING button repeatedly to change the brightness of your screen.
	Show the Option menu.
	Hides the option window. To display the options, press OK .
	When you press the EXIT button while the Music player is displayed, only the music will be stopped and the player will not return to normal viewing. When you press the EXIT button while the music is stopped or while the music player is hidden, the player will return to normal viewing.
"<" or ">"	When using the < or > button during playback a cursor indicating the position can be played.

Tips for Playing Music Files

- This unit doesn't support the ID3 Tag embedded MP3 files.

NOTE

- Non-supported files are displayed the preview image by icon only .
- Abnormal files are displayed in the form of bitmap .
- A damaged or corrupted music does not play but displays 00:00 in playtime.
- A music downloaded from a paid service with copyright protection does not start but displays inappropriate information in playtime.
- If you press OK, buttons, screen saver is stopped.
- The PLAY() , Pause() , , , buttons on the remote control are also available in this mode.
- You can use the button to select the next music and the button to select the previous music.

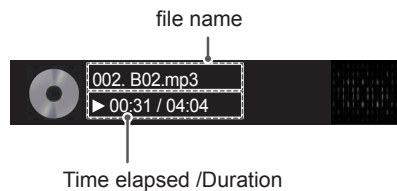

Music Options

- 1 Press **MENU** to access the **Pop-Up** menus.
- 2 Press the navigation buttons to scroll to **Set Audio Play.** or **Set Audio.** and press **OK**.

! NOTE

- Option values changed in **Movie List** does not affect **Photo List** and **Music List**.
- Option value changed in **Photo List** and **Music List** are changed likewise in **Photo List** and **Music List** excluding **Movie List**.

When you select the **Set Audio Play.**,

- 1 Press the navigation buttons to scroll to select the **Repeat** or **Random**.
- 2 Press the navigation buttons to scroll to make appropriate adjustments.

When you select the **Set Audio.**,

- 1 Press the navigation buttons to scroll to select the **Sound Mode**, **Clear Voice II** or **Balance**.
- 2 Press the navigation buttons to scroll to make appropriate adjustments.

Viewing the Contents List

Plays back the stored files using the Export option in SuperSign Manager.

- 1 Press the navigation buttons to scroll to **My Media** and press **OK**.
- 2 Press the navigation buttons to scroll to **Contents List** and press **OK**.
- 3 Press the navigation buttons to scroll to a folder you want and press **OK**.
- 4 Press the navigation buttons to scroll to a file you want and press **OK**.

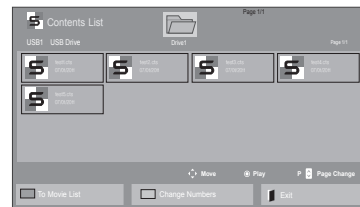

! NOTE

- While playing media files from Contents List, only the **BACK**, **EXIT**, or **Volume** button are available. Selecting the **BACK** or **EXIT** button stops playing media files and returns to the screen view mode.
- If there is the **AutoPlay** folder in the USB device and its files are in supported formats, they can be played back automatically when the USB device is connected to the monitor.

DivX® VOD Guide

DivX® VOD Registration

In order to play purchased or rented DivX® VOD contents, you should register your device with 10 digit DivX registration code from your device at www.divx.com/vod.

- 1 Press **MENU** to access the main menus.
- 2 Press the navigation buttons to scroll to **MY MEDIA** and press **OK**.
- 3 Press the Blue button.
- 4 Press the navigation buttons to scroll to **DivX Reg. Code** and press **OK**.
- 5 View the registration code of your display.
- 6 When you are finished, press **EXIT**.
When you return to the previous menu, press **BACK**.

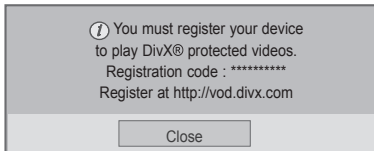

! NOTE

- While you are checking the registration code, some buttons may not work.
- If you use the DivX registration code of another device, you cannot play the rented or purchased DivX file. Make sure to use the DivX registration code assigned to your product.
- The video or audio files that are not converted by the standard DivX codec may be corrupted or not be played.
- The DivX VOD code allows you to activate up to 6 devices under one account.

DivX® VOD Deregistration

You should deregister your device with 8 digit DivX deregistration code from your device at www.divx.com/vod.

- 1 Press **MENU** to access the main menus.
- 2 Press the navigation buttons to scroll to **MY MEDIA** and press **OK**.
- 3 Press the Blue button.
- 4 Press the navigation buttons to scroll to **Deactivation** and press **OK**.
- 5 Press the navigation buttons to select **Yes** to confirm.

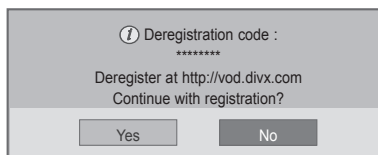

- 6 When you are finished, press **EXIT**.
When you return to the previous menu, press **BACK**.

NOTE

- Once the deregistration is executed, you must register your device again to see DivX® VOD contents.

Using PIP/PBP

Videos or pictures stored on the USB device can be displayed on a single monitor by dividing them into the main and subscreens.

- 1 Press the **MENU** button to move to **OPTION** and press **OK**.
- 2 Press **PIP/PBP** to select **PIP** or **PBP** and then press **OK**.

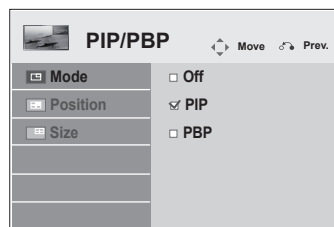

- 3 Select **Movie List** or **Photo List** from **My Media**.



4 Select a file you want and then press **OK**.

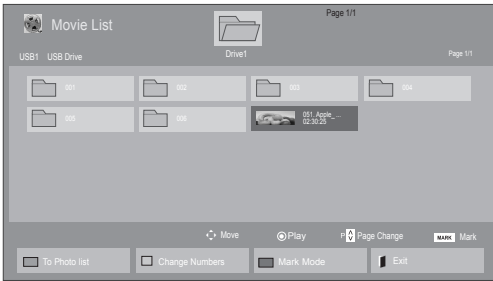

5 Select the **PIP** or **PBP** icon from the play list.



< MOVIE LIST >

6 For sound select either Main or Sub. You must to select the output sound before running the **PIP** or **PBP** function.

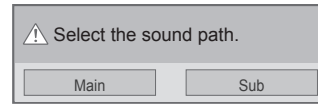

7 The sub screen is displayed on the main screen.



< PHOTO LIST >

CUSTOMIZING SETTINGS

Accessing Main Menu

- 1 Press **MENU** to access the main menus.
- 2 Press the navigation buttons to scroll to one of the following menus and press **OK**.
- 3 Press the navigation buttons to scroll to the setting or option you want and press **OK**.
- 4 When you are finished, press **EXIT**.
When you return to the previous menu, press **BACK**.

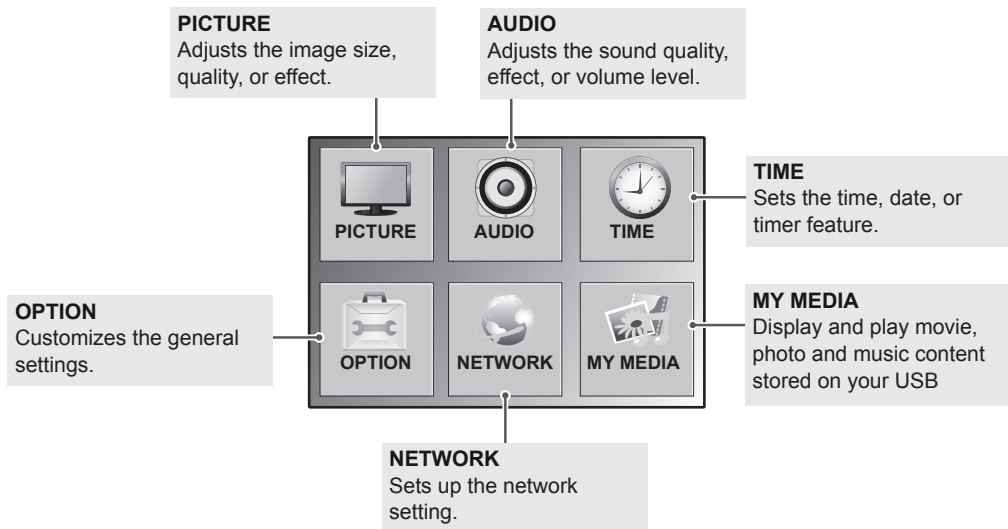
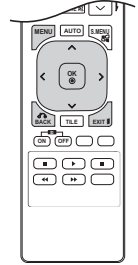

PICTURE Settings

- 1 Press **MENU** to access the main menus.
- 2 Press the Navigation buttons to scroll to **PICTURE** and press **OK**.
- 3 Press the Navigation buttons to scroll to the setting or option you want and press **OK**.
 - To return to the previous level, press **BACK**.
- 4 When you are finished, press **EXIT**.
When you return to the previous menu, press **BACK**.

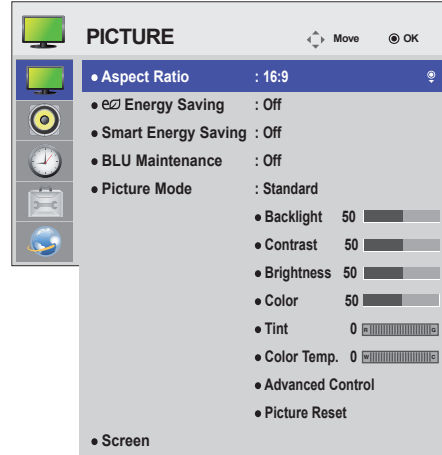

The available picture settings are described in the following:

Setting	Description
Aspect Ratio	Changes the image size to view images at its optimal size.
Energy Saving	Sets to automatically adjust the screen brightness corresponding to the surroundings.
	Level
	Auto Adjust automatically
	Off Disables Energy Saving function
	Minimum/ Medium/ Maximum Selects the brightness level of the backlight.
	Screen off The screen turns off in 3 seconds.
Smart Energy Saving	Adjusts the backlight and contrast depending on the screen brightness.
	Level
	Off Disables the Smart Energy Saving function.
	On Enables the Smart Energy Saving function to save power consumption as much as the value set in the smart energy saving rate.
BLU Maintenance	Enables or disables the luminance maintenance function.
Picture Mode	Selects one of the preset image or customizes options in each mode for the best monitor screen performance. You are also able to customize advanced options of each mode. The available preset picture modes vary depending on the monitor .
	Mode
	Vivid Adjusts the video image for the retail environment by enhancing the contrast, brightness, color, and sharpness.
	Standard Adjusts the image for the normal environment.
	Cinema Optimizes the video image for a cinematic look to enjoy movies as if you are in a movie theater.
	Sport Optimizes the video image for high and dynamic actions by emphasizing primary Colors such as white, grass, or sky blue.
	Game Optimizes the video image for a fast gaming screen such as PCs or games.

Setting	Description	
SCREEN (In RGB Mode Only)	Customizes the PC display options in RGB mode.	
	Option	
	Resolution	Selects a proper resolution. See "Customizing PC display options".
	Auto Config.	Adjusts the screen position, clock, and phase automatically. The displayed image may be unstable for a few seconds while the configuration is in progress.
	Position/Size/Phase	Adjusts the options when the picture is not clear, especially when characters are shaky. Run Auto Config. before adjusting these.
Reset	Restores all options to the default setting.	

Picture Mode Options

Setting	Description
Backlight	Adjusts the brightness of the screen by controlling the LCD backlight. If you decrease the brightness level, the screen becomes darker and the power consumption will be reduced without any video signal loss.
Contrast	Increases or decreases the gradient of the video signal. You may use contrast when the bright part of the picture is saturated.
Brightness	Adjusts the base level of the signal in the picture. You may use brightness when the dark part of the picture is saturated.
Sharpness	Adjusts the level of crispness in the edges between the light and dark areas of the picture. The lower the level, the softer the image.
Color	Adjusts intensity of all colors.
Tint	Adjusts the balance between red and green levels.
Color Temp.	Set to warm to enhance hotter colors such as red, or set to cool to make picture bluish.
Advanced Control	Customizes the advanced options. Refer to the advanced image options.
Picture Reset	Restores the options to the default setting.

! NOTE

- When using the Smart Energy Saving function, the screen may look saturated in the white area of a still image.
- If Energy Saving is set to minimum, medium, or maximum, the Smart Energy Saving function is disabled.
- If the Smart Energy Saving function is enabled, the BLU Maintenance function may not work properly.
- If the Smart Energy Saving function is enabled, the image on the screen may look darker.

Advanced Control

Setting	Description
Dynamic Contrast (Off/High/Medium/Low)	Adjusts the contrast to keep it at the best level according to the brightness of the screen. The picture is improved by making bright parts brighter and dark parts darker. (Function works in the following mode - AV (CVBS), Component, HDMI-DTV, Display Port-DTV)
Dynamic Color (Off/High/Low)	Adjusts screen colors so that they look livelier, richer and clearer. This feature enhances hue, saturation and luminance so that red, blue, green and white look more vivid. (Function works in the following mode - AV (CVBS), Component, HDMI-DTV, Display Port-DTV)
Clear White (Off/High/Low)	Make the white area of screen brighter and more white.
Skin Color (-5 to 5)	It detects the skin area of video and adjusts it to express a natural skin color.
Noise Reduction (Off/High/Medium/Low)	Reduces screen noise without compromising video quality. (Function works in the following mode - AV (CVBS), Component, HDMI-DTV, Display Port-DTV)
Digital Noise Reduction (Off/High/Medium/Low)	This option reduces the noise produced while creating digital video signals.
Gamma (High/Medium/Low)	Set your own gamma value. On the monitor, high gamma values display whitish images and low gamma values display high contrast images.
Black Level (High/Low)	<ul style="list-style-type: none"> ● Low: The picture of the screen gets darker. ● High: The picture of the screen gets brighter. Set black level of the screen to proper level. (Function works in the following mode - AV (CVBS), Component, HDMI-DTV, Display Port-DTV)

AUDIO Settings

- 1 Press **MENU** to access the main menus.
- 2 Press the navigation buttons to scroll to **AUDIO** and press **OK**.
- 3 Press the navigation buttons to scroll to the setting or option you want and press **OK**.
 - To return to the previous level, press **BACK**.
- 4 When you are finished, press **EXIT**.
When you return to the previous menu, press **BACK**.

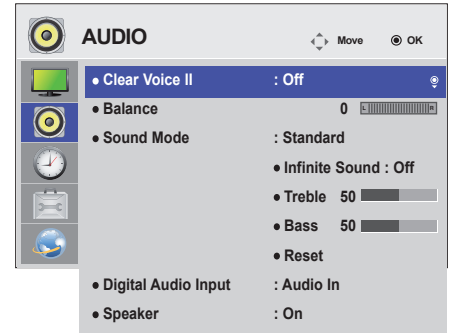

The available audio options are described in the following:

Setting	Description												
Clear Voice II	By differentiating the human sound range from others, it helps users makes dialog easier to understand.												
Balance	Adjusts balance between the left and right speakers according to your room environment.												
Sound Mode	<table border="1"> <thead> <tr> <th>Mode</th> <th>Description</th> </tr> </thead> <tbody> <tr> <td>Standard</td> <td>Select when you want standard-quality sound.</td> </tr> <tr> <td>Music</td> <td>Select when you listen to music.</td> </tr> <tr> <td>Cinema</td> <td>Select when you watch movies.</td> </tr> <tr> <td>Sport</td> <td>Select when you watch sport events.</td> </tr> <tr> <td>Game</td> <td>Select when you play games.</td> </tr> </tbody> </table>	Mode	Description	Standard	Select when you want standard-quality sound.	Music	Select when you listen to music.	Cinema	Select when you watch movies.	Sport	Select when you watch sport events.	Game	Select when you play games.
Mode	Description												
Standard	Select when you want standard-quality sound.												
Music	Select when you listen to music.												
Cinema	Select when you watch movies.												
Sport	Select when you watch sport events.												
Game	Select when you play games.												
Digital Audio Input	<p>HDMI/Display Port: Outputs the sound of digital signal from HDMI and display ports through the monitor speaker.</p> <p>Audio In: Outputs the sound through the monitor speaker by connecting HDMI and display ports to the Audio In port.</p>												
Speaker	<p>*The monitor speaker is sold separately.</p> <p>ON: Enables sound to the monitor speaker.</p> <p>OFF: Disables sound to the monitor speaker. Use this option when using an external sound device.</p>												

Sound Mode Options

Setting	Description
Infinite Sound	LG's Infinity Sound option provides 5.1 channel stereo sound from two speakers.
Treble	Controls the dominant sounds in the output. When you turn up the treble, it will increase the output to the higher frequency range.
Bass	Controls the softer sounds in the output. When you turn up the bass, it will increase the output to the lower frequency range.
Reset	Resets the sound mode to the default setting.

TIME Settings

- 1 Press **MENU** to access the main menus.
- 2 Press the navigation buttons to scroll to **TIME** and press **OK**.
- 3 Press the navigation buttons to scroll to the setting or option you want and press **OK**.
 - To return to the previous level, press **BACK**.
- 4 When you are finished, press **EXIT**.
When you return to the previous menu, press **BACK**.

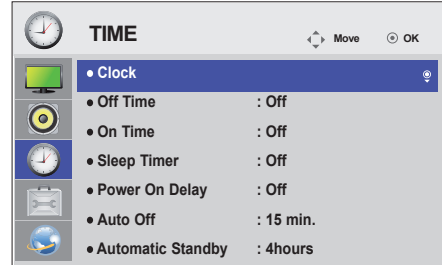

The available time settings are described in the following:

Setting	Description
Clock	Sets the time feature.
Off/On Time	Sets the time to turn on or off the monitor.
Sleep Timer	Sets the length of time until the monitor to turns off. When you turn the monitor off and turn it on again, the Sleep Timer will be set to off.
Power on delay	When connecting multiple monitors and turning the power on, the monitors are turned on individually to prevent overload.
Auto off	If Auto off is active and there is no input signal, the set switches to off mode automatically after 15 minutes.
Automatic Standby	If you do not use the monitor for more than 4 hours, it will be in off mode automatically.

NOTE

- Off/On Time can be saved for up to seven schedules; the monitor is turned on or off at the preset time in the schedule list. If multiple preset times are stored in the schedule list, this function works at the nearest time from the current time.
- The scheduled power-off function works properly only when the device time is set correctly.
- When the scheduled power-on and power-off times are the same, the power-off time has priority over the power-on time if the set is turned on, and vice versa if the set is turned off.
- The Automatic Standby and Auto off functions may not be available in some countries.



OPTION Settings

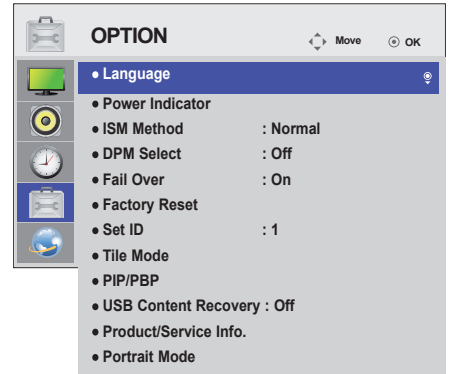

- 1 Press **MENU** to access the main menus.
- 2 Press the navigation buttons to scroll to **OPTION** and press **OK**.
- 3 Press the navigation buttons to scroll to the setting or option you want and press **OK**.
 - To return to the previous level, press **BACK**.
- 4 When you are finished, press **EXIT**.
 - When you return to the previous menu, press **BACK**.



The available option settings are described in the following:

Setting	Description
Language	To choose the language in which the control names are displayed.
Power Indicator	Use this function to set the power indicator on the front side of the product to on or off.
ISM Method	A frozen or still picture from a PC/Video game displayed on the screen for prolonged periods could result in a ghost image remaining even when you change the image. Avoid allowing a fixed image to remain on the screen for a long period of time.
Setting	
Normal	Leave on normal if you don't foresee image burn in being a problem.
Orbiter	May help prevent ghost images. However, it is best not to allow any fixed image to remain on the screen. To avoid a permanent image on the screen, the screen will move every 2 minutes.
Inversion	This function inverts the panel color of the screen. The panel color is automatically inverted every 30 minutes.
White Wash	White wash fills the screen with solid white. This helps removes permanent images burned into the screen. A permanent image may be impossible to clear entirely with white wash.
DPM Select	A user can choose to turn the power saving mode on / off.
Fail Over	If there is no input signal, it automatically switches to another input with signal.
Setting	
Off	Stops auto switch of the input source.
Auto	Switches to another input source with video signal if no video signal comes from the current input source.
Manual	Selects the priority of input source for auto switch. When several input sources are found, the input source with a higher priority will be selected.
Factory Reset	Select this option to return to the default factory settings.
Set ID	You can assign a unique Set ID NO (name assignment) to each product when several products are connected for display. Specify the number (1 to 255) using the button and exit. Use the assigned Set ID to individually control each product using the Product Control Program.

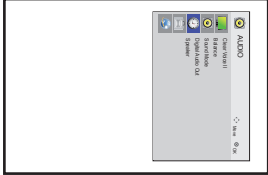
Setting	Description
Tile Mode	Tile Mode To use this function - Must be displayed with various other products. - Must be in a function that can be connected to RGB Cable by distributor and RS-232C. Tile mode and choose Tile alignment and set the ID of the current product to set location. * Only after pressing the SET button the adjustments made to the settings will be saved. - Tile mode : column x row (c = 1, 2, 3, 4, 5 r = 1, 2, 3, 4, 5) - 15 x 15 available. - Configuration of an integration screen is also available as well as configuration of One by one Display.
	Auto Config. Adjusts the screen position automatically. The displayed image may be unstable for a few seconds while the configuration is in progress.
	PC Position Moving the screen position horizontally and vertically.
	PC Size Adjust the horizontal and vertical size of the screen taking into account the size of the bezel.
	Natural The image is omitted by the distance between the screens to be naturally shown.
	Reset Function to initialize and release Tile. All Tile setting are released when selecting Tile recall and the screen returns to Full screen.
<div style="border: 1px solid black; border-radius: 10px; padding: 10px;"> <p> NOTE</p> <ul style="list-style-type: none"> • If Tile Mode is enabled, Smart Energy Saving and the Auto option in Energy Saving will be disabled to provide the same picture quality as other displays. </div>	
PIP/BPB	Videos or photos stored on the USB device can be displayed on a single monitor by dividing them into the main and subscreens.
	Option
	Mode Sets the type of secondary screen. *OFF: Disables the secondary screen. *PIP (Picture In Picture): Displays the secondary screen in the main screen. *PBP (Picture By Picture): Displays the secondary screen next to the main screen.
	Position Adjusts the position of the subscreen (top left, bottom left, top right, bottom right) The default value is in the bottom right.
	Size Adjusts the size of the subscreen (Size 0-10). The default size of the PIP (Size: 0) is 480x270; the maximum size (Size: 10) is 960x540.
<div style="border: 1px solid black; border-radius: 10px; padding: 10px;"> <p> NOTE</p> <ul style="list-style-type: none"> • The position and size options are enabled only in PIP mode. </div>	

Setting	Description
USB Content Recovery	Replays the content in a USB when the power is back on if it is turned off during playing a content. (This function operates the same when a USB is disconnected and connected again.)
Product/Service Info.	Displays the model name, software version, serial number, IP address, MAC address and home page.
Portrait Mode	Rotate OSD clockwise (90°,270°)
	Option
	90° Rotate OSD clockwise 90°.
	270° Rotate OSD clockwise 270°.
	<div style="display: flex; justify-content: space-around; align-items: center;"> <div style="text-align: center;">  <p>90°</p> </div> <div style="text-align: center;">  <p>270°</p> </div> </div>

Tile Mode

This monitor can be tiled with additional monitors to create a large tiled display.

Off
When the Tile Mode option is disabled

1X2
When using 2 monitors



Tile ID

2X2
When using 4 monitors



3X3
When using 9 monitors



4X4
When using 16 monitors



5X5
When using 25 monitors



Tile Mode - Natural Mode

When active, the part of the image that would normally be displayed in the gap between the monitors is omitted.

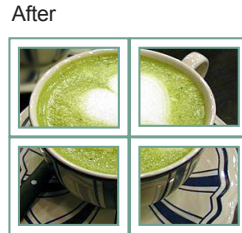
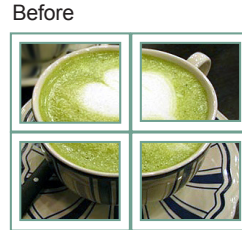

PIP/PBP

Displays videos or photos stored in the USB device on a single monitor by dividing it into the main and sub screens.

Mode

***PIP (Picture In Picture)**: Displays the Sub screen in the main screen.

***PBP (Picture By Picture)**: Displays the Sub screen next to the main screen.

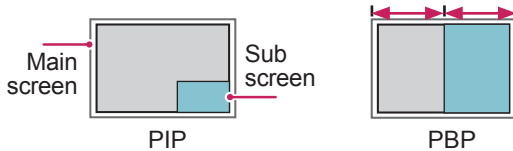

Position

Adjusts the position of the subscreen (top left, bottom left, top right, bottom right)

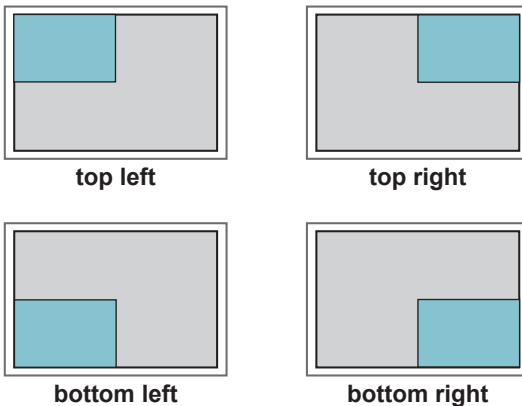

Size

Adjusts the size of the subscreen (Size 0-10).

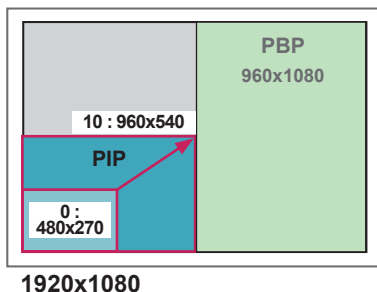

NOTE

- The subscreen is only supported when using the USB device.

		Sub
		USB
Main	Component	O
	RGB	O
	HDMI/DVI-D/Display Port	O
	AV	X

- You can only change the size and position in PIP mode.
- With PBP selected, the Aspect Ratio option in the PICTURE menu is disabled (Fixed as 16:9).
- While running the PBP function, the Tile Mode function does not work.
- You must select the output sound before running the PIP or PBP functions. (Select either Main or Sub.)
- If you fail to select Main or Sub from the sound selection box, and if the OSD disappears after either a period of time or when the Exit or Back key is pressed, the PIP/PBP subscreen is not activated.
- You cannot change the sound while running the PIP or PBP functions. If you want to change the sound, please restart PIP/PBP.
- The picture quality of the subscreen is set according to the values selected in the main menu, not the USB device.
- Even when the power is turned off or on, if the USB device is connected, the PIP/PBP mode plays again from where it left off.
- If you play videos you selected in PIP/PBP mode, the videos will play back repeatedly in succession.
- The buttons below work in PIP mode.

Button	Photo	Movie
"<"	O	X
">"	O	X
▶	X	O
■	X	X
▶▶	X	O
◀◀	X	O
⏸	X	O

NETWORK Settings

- 1 Press **MENU** to access the main menus.
- 2 Press the navigation buttons to scroll to **NETWORK** and press **OK**.
- 3 Press the navigation buttons to scroll to the setting or option you want and press **OK**.
 - To return to the previous level, press **BACK**.
- 4 When you are finished, press **EXIT**.
When you return to the previous menu, press **BACK**.

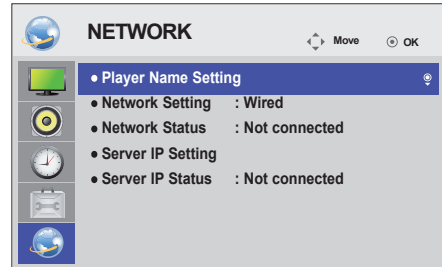

The available option settings are described in the following:

Setting	Description
Player Name	Sets the player name used in SuperSign Manager. (Up to 20 characters)
Network Setting	Configure the network settings.
Network Status	Display the network status. - Internet is connected: Externally connected - Home network is connected: Only internally connected - Not connected: When there is no network connection
Server IP Setting	Sets the IP address of the computer (server) on which SuperSign Manager is installed.
Server IP Status	Displays the connection status with the server. - Not connected: When there is no network connection with SuperSign server - Waiting for approval: When network connection with SuperSign server has been made, but access to server has not been approved by the server - Rejected: When network connection with SuperSign server has been made, but access to server has been rejected by the server - Internet is connected: When network connection with SuperSign server has been made and access to server has also been approved by the server



CAUTION

- When setting the Player Name, input delay may occur if you press the buttons on the remote control continuously.

MAKING CONNECTIONS

Connect various external devices to the ports on the monitor's back panel.

- 1 Find an external device you want to connect to your monitor shown on the following illustration.
- 2 Check the connection type of the external device.
- 3 Go to the appropriate illustration and check the connection details.

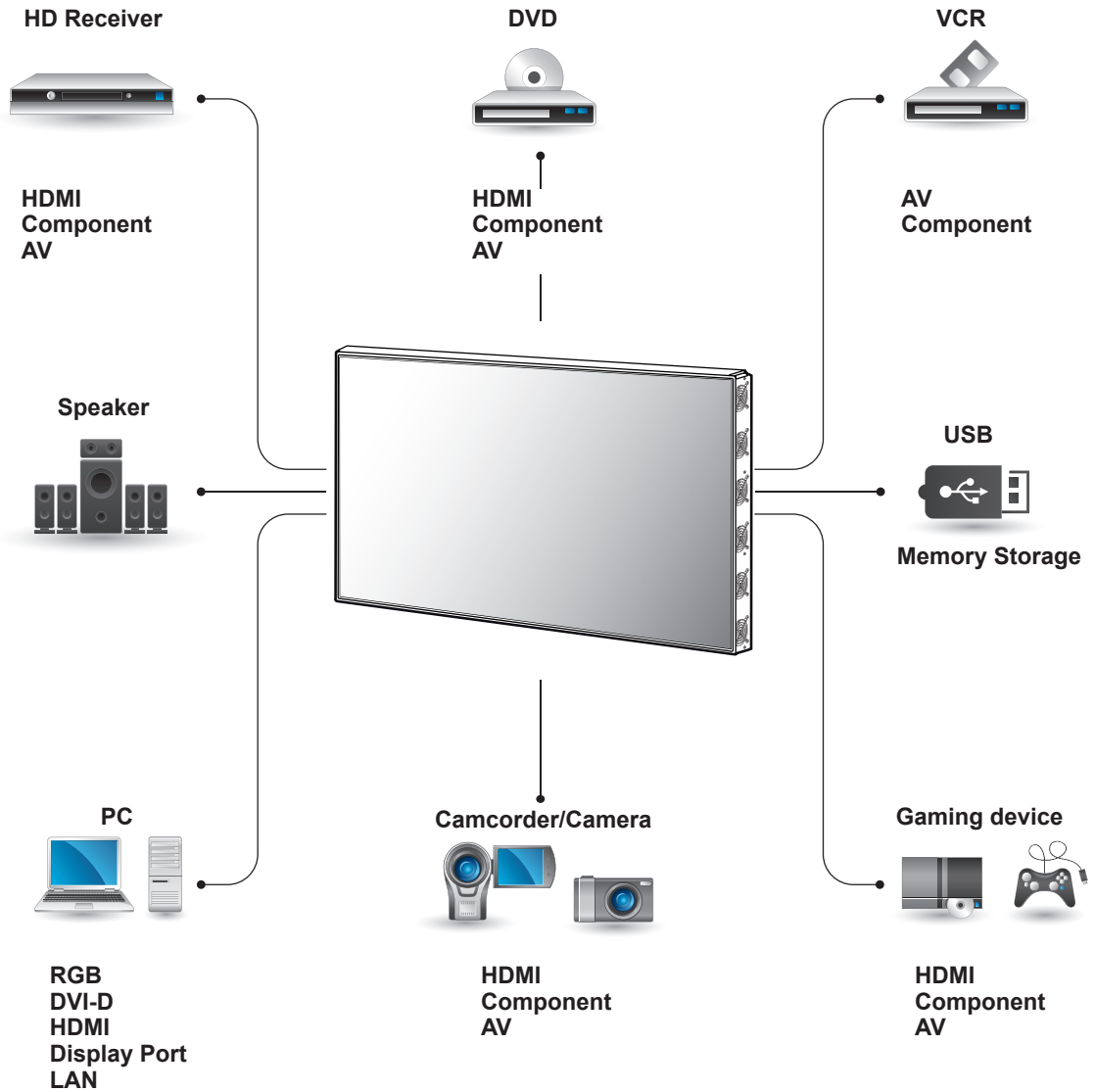

NOTE

- If you connect a gaming device to the monitor, use the cable supplied with the gaming device.

Connecting to a HD receiver, DVD, Camcorder, Camera, Gaming Device or VCR player

Connect a HD receiver, DVD, or VCR player to the Monitor and select an appropriate input mode.

HDMI Connection

Transmits the digital video and audio signals from an external device to the monitor. Connect the external device and the monitor with the HDMI cable as shown on the following illustration.

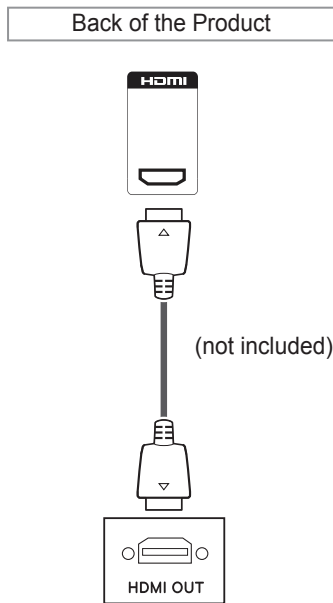

Component Connection

Transmits the analog video and audio signals from an external device to the monitor. Connect the external device and the monitor with the 15 pin signal to RCA cable as shown on the following illustration. To display images by using progressive scan, make sure to use the component cable.

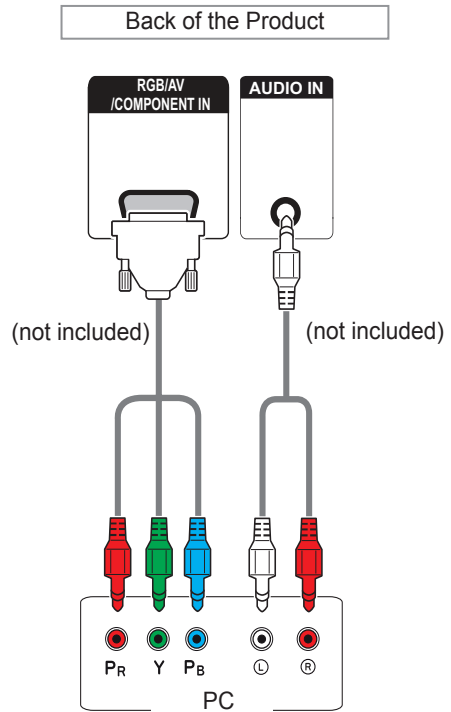

NOTE

- Use a High Speed HDMI™ Cable.
- High Speed HDMI™ Cables are tested to carry an HD signal up to 1080p and higher.

AV (CVBS) Connection

Transmits the analog video and audio signals from an external device to the monitor. Connect the external device and the monitor with the 15 pin signal to RCA cable as shown on the following illustration.

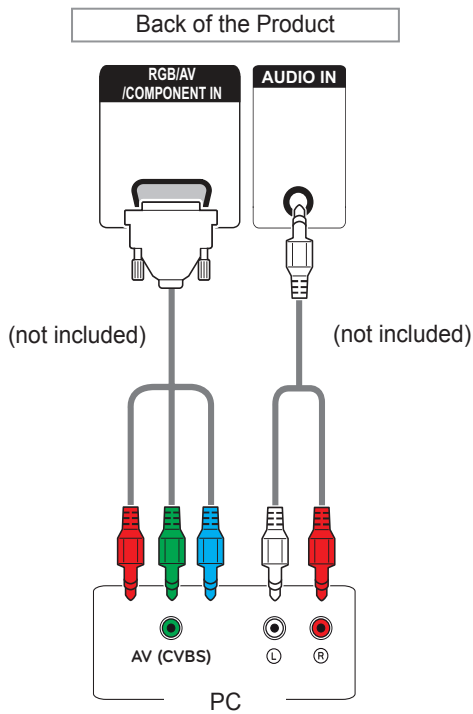

Connecting to a USB

Connect a USB storage device such as a USB flash memory, external hard drive, MP3 player, or a USB memory card reader to the monitor and access the USB menu to use various multimedia files.

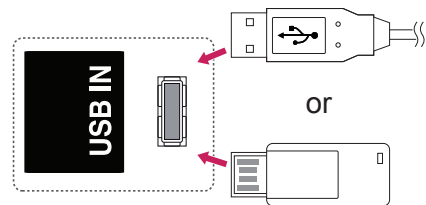

Connecting to the LAN

LAN Connection

NOTE

- Using LAN establishes communication between your PC and the monitor and enables to use the OSD menus on the PC as well as on the monitor.

A Connect PC to monitor directly.

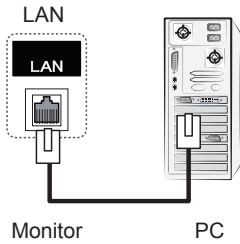

B Using a router (Switch)

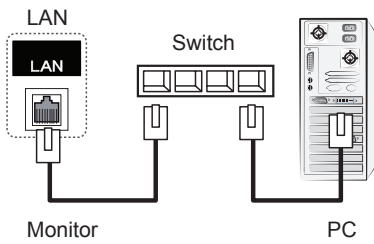

C Using the Internet.

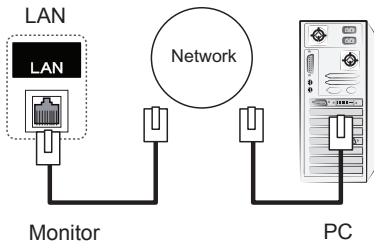

Daisy Chain Monitors

Use this function to share the RGB video signal with other monitors without having to use a separate signal splitter box.

To use different products connected to each other Connect one end of the signal input cable (15-pin D-Sub Signal Cable) to the RGB OUT connector of product 1 and connect the other end to the RGB IN connector of other products

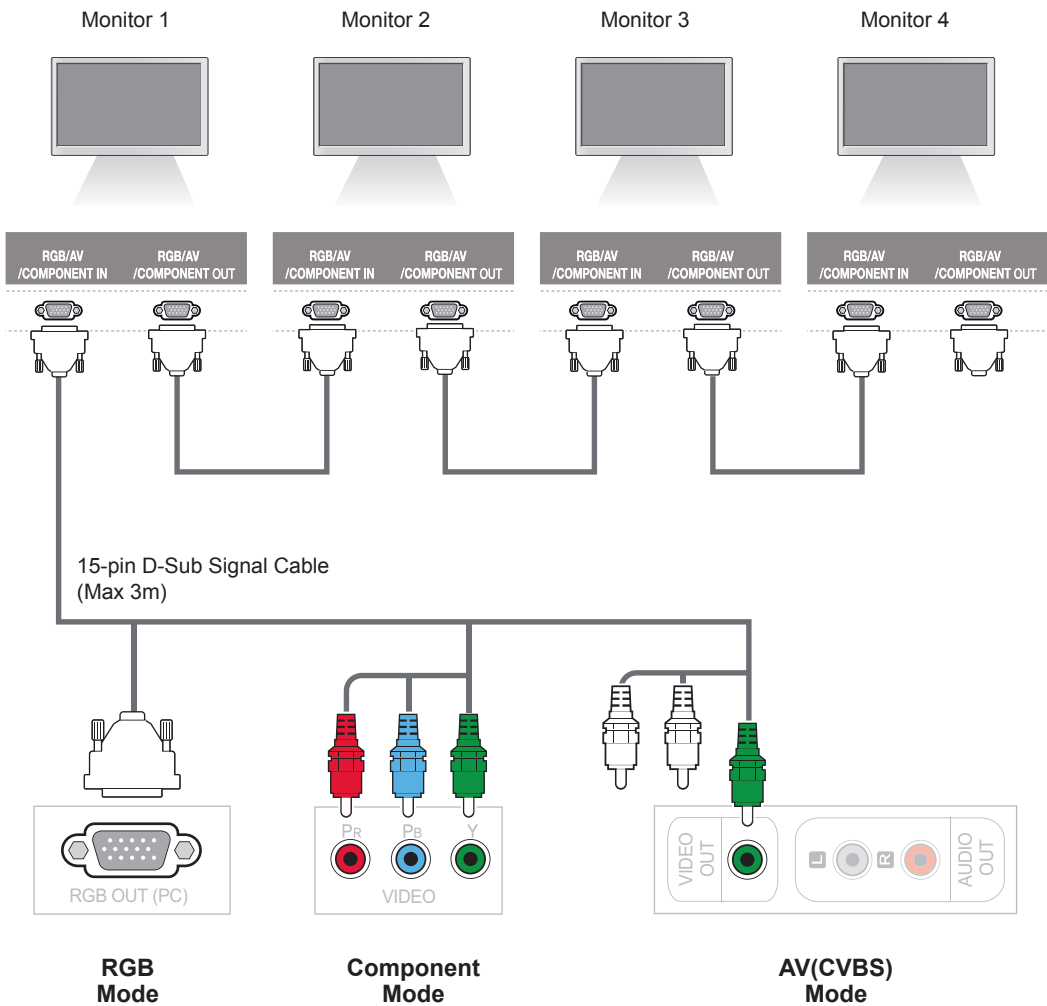

NOTE

- The number of monitors that can be connected to one output may vary depending on signal status and cable loss. If the signal status is good, and there is no cable loss, it is possible to connect up to 9 monitors. If you want to connect more than this number of monitors, it is recommended to use a distributor.
- When multi-connecting in/out cascade format, no loss cables are recommended.

TROUBLESHOOTING

No image is displayed

Problem	Resolution
Is the product power cord connected?	<ul style="list-style-type: none"> • See if the power cord is properly connected to the outlet.
Is the power indicator light on?	<ul style="list-style-type: none"> • See if the power switch is turned on. • May need service.
Power is on, power indicator is red but the screen appears extremely dark.	<ul style="list-style-type: none"> • Adjust brightness and contrast again. • Backlight may need repair.
The power indicator amber?	<ul style="list-style-type: none"> • If the product is in power saving mode, move the mouse or press any key. • Turn both devices off and then back on.
Does the 'Out of range' message appear?	<ul style="list-style-type: none"> • The signal from the PC (video card) is out of the vertical or horizontal frequency range of the product. Adjust the frequency range by referring to the Specifications in this manual. <p>* Maximum resolution RGB, HDMI, DVI-D, Display Port: 1920 x 1080 @ 60 Hz</p>
Does the 'Check signal cable' message appear?	<ul style="list-style-type: none"> • The signal cable between PC and product is not connected. Check the signal cable. • Press the INPUT menu in the remote Control to check the input signal. • There may be a poor signal transmission occurring intermittently between the external device and LG monitor set. Disconnect the signal cable and then reconnect it. Turn the external device or the LG monitor set off and then on again.

'Unknown Product' message appears when the product is connected.

Problem	Resolution
Did you install the driver?	<ul style="list-style-type: none"> • Install the product driver, which is provided with the product, or download it from the web site. (http://www.lg.com) • See if the plug&play function is supported by referring to the video card user manual.

The screen image looks abnormal.

Problem	Resolution
Is the screen position wrong?	<ul style="list-style-type: none"> • D-Sub analog signal - Press the AUTO button in the remote control to automatically select the optimal screen status that fits into the current mode. If adjustment is not satisfactory, use the Position OSD menu. • See if the video card resolution and frequency are supported by the product. If the frequency is out of range, set to the recommended resolution in the Control Panel Display Setting menu.
Do thin lines appear on the background screen?	<ul style="list-style-type: none"> • D-Sub analog signal - Press the AUTO button in the remote control to automatically select an optimal screen status that fits into the current mode. If adjustment is not satisfactory, use the Clock OSD menu.
Horizontal noise appears or the characters look blurred.	<ul style="list-style-type: none"> • D-Sub analog signal - Press the AUTO button in the remote control to automatically select an optimal screen status that fits into the current mode. If adjustment is not satisfactory, use the Phase OSD menu.
The screen is displayed abnormally.	<ul style="list-style-type: none"> • The proper input signal is not connected to the signal port. Connect the signal cable that matches with the source input signal. • There may be a poor signal transmission occurring intermittently between the external device and LG monitor set. Disconnect the signal cable and then reconnect it. Turn the external device or the LG monitor set off and then on again.
When setting the resolution for external devices, some resolution values are not shown correctly in the resolution settings screen.	<ul style="list-style-type: none"> • Restart the external devices while the LG monitor is powered on. After restarting the external devices, check if the resolution values are displayed correctly.

After-image appears on the product.

Problem	Resolution
After-image appears when the product is turned off.	<ul style="list-style-type: none"> • If you use a fixed image for a long time, the pixels may be damaged quickly. Use the screen-saver function.

The audio function does not work.

Problem	Resolution
No sound?	<ul style="list-style-type: none"> • See if the audio cable is connected properly. • Adjust the volume. • See if the sound is set properly.
Sound is too dull.	<ul style="list-style-type: none"> • Adjust the Clear Voice II, Treble and Bass appropriately.
Sound is too low.	<ul style="list-style-type: none"> • Adjust the volume.

Screen color is abnormal.

Problem	Resolution
Screen has poor color resolution (16 colors).	<ul style="list-style-type: none"> Set the number of colors to more than 24 bits (true color) Select Control Panel - Display - Settings - Color Table menu in Windows.
Screen color is unstable or mono-colored.	<ul style="list-style-type: none"> Check the connection status of the signal cable. Or, re-insert the PC video card.
Do black spots appear on the screen?	<ul style="list-style-type: none"> Several pixels (red, green, white or black color) may appear on the screen, which can be attributable to the unique characteristics of the LCD panel. It is not a malfunction of the LCD.

The operation does not work normally.

Problem	Resolution
The power suddenly turned off.	<ul style="list-style-type: none"> Is the sleep timer set? Check the power control settings. Power interrupted

SPECIFICATIONS

LCD Panel	Screen Type	1830.616 mm Wide (72.07 inch) TFT (Thin Film Transistor) LCD (Liquid Crystal Display) Panel Visible diagonal size: 1830.616 mm
	Pixel Pitch	0.831 mm (H) x 0.831 mm (V)
Video Signal	Max. Resolution	RGB : 1920 X 1080 @60 Hz HDMI,DVI-D, Display Port: 1920 X 1080 @60 Hz - It may not be supported depending on the OS or video card type.
	Recommended Resolution	RGB: 1920 X 1080 @60 Hz HDMI,DVI-D, Display Port: 1920 X 1080 @60 Hz - It may not be supported depending on the OS or video card type.
	Horizontal Frequency	RGB: 30 kHz to 83 kHz HDMI,DVI-D, Display Port: 30 kHz to 83 kHz
	Vertical Frequency	RGB: 56 Hz to 75 Hz HDMI,DVI-D, Display Port: 56 Hz to 60 Hz
	Synchronization Type	Separate Sync, Composite Sync, Digital
Input Connector	15-pin D-Sub, HDMI, DVI-D, Display Port, RS-232C, LAN, USB, Audio	
Power	Rated Voltage	100-240 V~ 50/60 Hz 12.0 A
	Power Consumption	On Mode: 1000 W Typ. 1300 W Max Sleep Mode (RGB): 1 W Sleep Mode (HDMI, DVI-D, Display Port) : 2 W (Set Only / With External Device) Off Mode: 1 W
Environmental conditions	Operating Temperature	0 °C to 50 °C
	Operating Humidity	10 % to 80 %
	Storage Temperature	-20 °C to 60 °C
	Storage Humidity	5 % to 95 %

Product specifications shown above may be changed without prior notice due to upgrade of product functions.

Dimensions (Width x Height x Depth) / Weight		
	1654.5 mm x 956.5 mm x 139.5 mm / 54.5 kg	

*** Applicable only for models that support the speakers**

Audio	RMS Audio Output	10 W + 10 W (R + L)
	Input Sensitivity	0.7 V _{rms}
	Speaker Impedance	8 Ω

Product specifications shown above may be changed without prior notice due to upgrade of product functions.

RGB (PC) supported mode

Resolution	Horizontal Frequency(kHz)	Vertical Frequency(Hz)
640 x 350	31.469	70.8
720 x 400	31.468	70.8
640 x 480	31.469	59.94
640 x 480	37.5	75
800 x 600	37.879	60.317
800 x 600	46.875	75
832 x 624	49.725	74.55
1024 x 768	48.363	60
1024 x 768	60.123	75.029
1280 x 720	44.772	59.855
1366 x 768	47.7	60
1280 x 1024	63.981	60.02
1280 x 1024	79.98	75.02
1680 x 1050	65.290	59.954
1920 x 1080	67.5	60

HDMI,DVI-D,Display Port (PC) supported mode

Resolution	Horizontal Frequency(kHz)	Vertical Frequency(Hz)
640 x 480	31.469	59.94
800 x 600	37.879	60.317
1024 x 768	48.363	60
1280 x 720	44.772	59.855
1366 x 768	47.7	60
1280 x 1024	63.981	60.02
1680 x 1050	65.290	59.954
1920 x 1080	67.5	60

DTV Mode

Resolution	Component	HDMI,Display Port (DTV)
480i	o	x
480p	o	o
576i	o	x
576p	o	o
720p	o	o
1080i	o	o
1080p	o	o

Power Indicator

Mode	Product
On Mode	Red
Sleep Mode	Amber
Off Mode	-



NOTE

- When the cable is connected to the HDMI or the display port, you can select the PC/DTV mode optionally. It is recommended you to set to the PC mode when connecting to PC; the DTV mode when connecting to DTV.

NOTE

- Vertical frequency: To enable the user to watch the product display, screen image should be changed tens of times every second like a fluorescent lamp. The vertical frequency or refresh rate is the times of image display per second. The unit is Hz.
- Horizontal frequency: The horizontal interval is the time to display one vertical line. When 1 is divided by the horizontal interval, the number of horizontal lines displayed every second can be tabulated as the horizontal frequency. The unit is kHz.

IR CODES

Code (Hexa)	Function	Note
95	ENERGY SAVING (e)	R/C BUTTON
08	POWER (b) ON/OFF	R/C BUTTON
0B	INPUT	R/C BUTTON
C4	MONITOR ON	R/C BUTTON (Discrete IR Code)
C5	MONITOR OFF	R/C BUTTON (Discrete IR Code)
43	MENU	R/C BUTTON
40	Up (^)	R/C BUTTON
41	Down (v)	R/C BUTTON
07	Left (<)	R/C BUTTON
06	Right (>)	R/C BUTTON
44	OK (o)	R/C BUTTON
28	BACK (o)	R/C BUTTON
5B	EXIT	R/C BUTTON
4D	PSM	R/C BUTTON
02	Volume  (+)	R/C BUTTON
03	Volume  (-)	R/C BUTTON
09	MUTE	R/C BUTTON
E0	BRIGHTNESS ^ (PAGE UP)	R/C BUTTON
E1	BRIGHTNESS v (PAGE Down)	R/C BUTTON
10 to 19	Number Key 0 to 9	R/C BUTTON
72	Red Key (ID ON)	R/C BUTTON
71	Green Key (ID OFF)	R/C BUTTON
63	Yellow Key	R/C BUTTON
61	Blue Key	R/C BUTTON
7B	TILE	R/C BUTTON
76	ARC (4:3)	Discrete IR Code
77	ARC (16:9)	Discrete IR Code
AF	ARC (ZOOM)	Discrete IR Code
79	ARC (MARK)	R/C BUTTON (Discrete IR Code)
99	Auto Config.	R/C BUTTON (Discrete IR Code)
B1	■	R/C BUTTON
B0	▶	R/C BUTTON
BA		R/C BUTTON
8F	◀	R/C BUTTON
8E	▶	R/C BUTTON

CONTROLLING THE MULTIPLE PRODUCT

- Use this method to connect several products to a single PC. You can control several products at a time by connecting them to a single PC.
- In the Option menu, Set ID must be between 1 and 255 without being duplicated.

Connecting the Cable

Connect the RS-232C cable as shown in the picture.

- The RS-232C protocol is used for communication between the PC and product. You can turn the product on/off, select an input source or adjust the OSD menu from your PC.

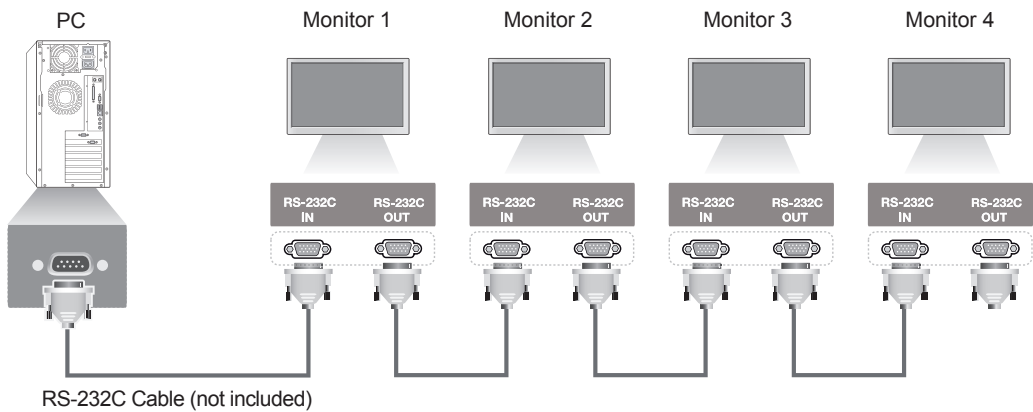

RS-232C Configurations

7-Wire Configurations (Standard RS-232C cable)

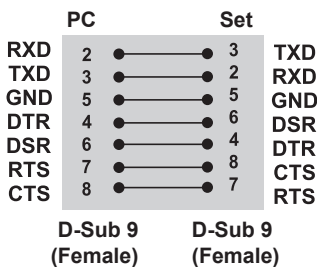

3-Wire Configurations (Not Standard)

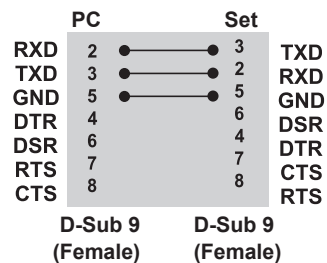

Communication Parameter

- Baud Rate: 9600 BPS
- Data Length: 8 bit
- Parity Bit: None
- Stop Bit: 1bit
- Flow Control: None
- Communication Code: ASCII code
- Use a crossed (reverse) cable

Command Reference List

	COMMAND		DATA (Hexadecimal)
	1	2	
01. Power	k	a	00 to 01
02. Input Select	x	b	Refer to 'Input Select.'
03. Aspect Ratio	k	c	Refer to 'Aspect Ratio.'
04. Energy Saving	j	q	Refer to 'Energy Saving.'
05. Picture mode	d	x	Refer to 'Picture mode.'
06. Contrast	k	g	00 to 64
07. Brightness	k	h	00 to 64
08. Sharpness	k	k	00 to 64
09. Color	k	i	00 to 64
10. Tint	k	j	00 to 64
11. Color Temperature	x	u	00 to 64
12. H Position	f	q	00 to 64
13. V Position	f	r	00 to 64
14. H Size	f	s	00 to 64
15. Auto configuration	j	u	01
16. Balance	k	t	00 to 64
17. Sound mode	d	y	Refer to 'Sound mode.'
18. Treble	k	r	00 to 64
19. Bass	k	s	00 to 64
20. Speaker	d	v	00 to 01
21. Volume Mute	k	e	00 to 01
22. Volume Control	k	f	00 to 64
23. Time 1 (Years/ Months/ Days)	f	a	Refer to 'Time 1.'
24. Time 2 (Hours/ Minutes/Seconds)	f	x	Refer to 'Time 2.'
25. Off Timer (Repeat mode/ Time)	f	e	Refer to 'Off Timer.'
26. On Timer (Repeat Mode/ Time)	f	d	Refer to 'On Timer.'
27. On Timer Input	f	u	Refer to 'On Timer Input.'
28. Sleep Time	f	f	00 to 08
29. Power On Delay	f	h	00 to 64
30. Automatic Standby	m	n	00 to 01
31. Auto Off	f	g	00 to 01
32. Language	f	i	Refer to 'Language.'
33. Power Indicator (Standby Light)	f	o	00 to 01
34. Power Indicator (Power Light)	f	p	00 to 01
35. ISM mode	j	p	Refer to 'ISM Method.'
36. Fail Over Select	m	i	00H to 02H
37. Fail Over Input Select	m	j	Refer to 'Fail Over Input Select.'
38. Reset	f	K	00 to 02

	COMMAND		DATA (Hexadecimal)
	1	2	
39. Tile Mode	d	d	00 to 01
40. Tile Mode Check	d	z	FF
41. Tile ID	d	i	Refer to 'Tile ID.'
42. Tile H Position	d	e	00 to 32
43. Tile V Position	d	f	00 to 32
44. Tile H Size	d	g	00 to 32
45. Tile V Size	d	h	00 to 32
46. Natural Mode (In Tile mode)	d	j	00 to 01
47. DPM Select	f	j	00 to 01
48. FAN Control	d	o	00 to 03
49. FAN Fault Check	d	w	FF
50. Temperature Value	d	n	FF
51. Remote Lock/ key Lock	k	m	00 to 01
52. Key	m	c	Refer to 'Key.'
53. OSD Select	k	l	00 to 01
54. Elapsed time return	d	l	FF
55. Serial No. Check	f	y	FF
56. S/W Version	f	z	FF
57. White Balance Red Gain	j	m	00 to FE
58. White Balance Green Gain	j	n	00 to FE
59. White Balance Blue Gain	j	o	00 to FE
60. Backlight	m	g	00 to 64
61. PC Power Control	d	t	00 to 01
62. PC Power	d	s	00 to 01
63. Reading luminance values	m	u	Refer to 'Reading luminance values'
64. Status check	s	v	Refer to 'Status check'
65. BLU Maintenance	m	t	00 to 01
66. Mirror mode	t	a	00 to 02

- Note : During USB operations such as Dvix or EMF, all commands except Power(k a) and Key(m c) are not executed and treated as NG.
- Some commands are not supported depending on the model.

Transmission / Receiving Protocol

Transmission

[Command1][Command2][][Set ID][][Data][Cr]

- * [Command1]: First command to control the set.
- * [Command2]: Second command to control the set.
- * [Set ID]: Set ID with which you want to communicate. Enter [Set ID] = '00(0x00)' to communicate with all sets regardless of their Set ID numbers.
- * [Data]: Information passed to the set.
- * [Data1]: Information passed to the set.
- * [Data2]: Information passed to the set.
- * [Data3]: Information passed to the set.
- * [Cr]: Carriage Return. ASCII code '0x0D'.
- * []: ASCII code space '0x20'

Acknowledgement

[Command2][][Set ID][][OK/NG][Data][x]

- * When the product receives data normally, it sends an acknowledgement (ACK) in the format above. If data is in read mode, it indicates the data that shows the current status. If data is in read mode, it simply indicates the data that is sent from the PC.
- * If a command is sent with Set ID '00' (=0x00), the data is reflected to all monitor sets and they do send any acknowledgement (ACK).
- * If the data value 'FF' is sent in control mode via RS-232C, the current setting value of a function can be checked (only for some functions).
- * Some commands are not supported depending on the model.

01. Power (Command: k a)

To control the Power On/Off the display.

Transmission

[k][a][][Set ID][][Data][Cr]

Data 00 : Off

01 : On

Acknowledgement

[a][][Set ID][][OK/NG][Data][x]

* Only when the monitor set is fully powered on, the Acknowledgement signal is returned properly.

* There may be a certain time of delay between the Transmission and Acknowledgement signals.

02. Input Select (Command: x b)

To select the Input Source for display.

Transmission

[x][b][][Set ID][][Data][Cr]

Data 20: Input (AV)

40: Component

60: RGB

70: DVI-D(PC)

80: DVI-D(DTV)

90: HDMI(HDMI1)(DTV)

A0: HDMI(HDMI1)(PC)

C0: Display Port(DTV)

D0: Display Port(PC)

91: HDMI2/SDI(DTV)

A1: HDMI2/SDI(PC)

B0: SuperSign

Acknowledgement

[b][][Set ID][][OK/NG][Data][x]

* Some input signals may not be supported depending on the model.

03. Aspect Ratio (Command: k c)

To adjust the screen format.

Transmission

[k][c][][Set ID][][Data][Cr]

Data 01: 4:3

02: 16:9

04: Zoom

(AV, Component, HDMI/ DVI-D/ Display Port DTV)

09: Just scan (720p or more)

(Component, HDMI/ DVI-D/ Display Port DTV)

* RGB, DVI-D, HDMI/Display Port PC mode (1:1)

10 to 1F: Cinema Zoom 1 to 16

(AV, Component, HDMI/ DVI-D/ Display Port DTV)

* Available data types differ depending on the input signal. For more information, see the aspect ratio section of the owner's manual.

* The aspect ratio may differ depending on the model's input configuration.

Acknowledgement

[c][][Set ID][][OK/NG][Data][x]

04. Energy Saving (Command: j q)

To set the Energy Saving function.

Transmission

[j][q][][Set ID][][Data][Cr]

Data 00: Off

01: Minimum

02: Medium

03: Maximum

04: Auto

05: Screen Off

Acknowledgement

[q][][Set ID][][OK/NG][Data][x]

** It may not be supported depending on the model.

05. Picture Mode (Command: d x)

To select the Picture Mode.

Transmission

[d][x][][Set ID][][Data][Cr]

Data 00: Vivid

01: Standard

02: Cinema

03: Sport

04: Game

Acknowledgement

[x][][Set ID][][OK/NG][Data][x]

06. Contrast (Command: k g)

To adjust the screen contrast.

Transmission

[k][g][][Set ID][][Data][Cr]

Data 00 to 64: Contrast 0 to 100

Acknowledgement

[g][][Set ID][][OK/NG][Data][x]

07. Brightness (Command: k h)

To adjust the screen brightness.

Transmission

[k][h][][Set ID][][Data][Cr]

Data 00 to 64: Brightness 0 to 100

Acknowledgement

[h][][Set ID][][OK/NG][Data][x]

08. Sharpness (Command: k k)

To adjust the screen sharpness.

* This function is available only in AV/Component input.

Transmission

[k][k][][Set ID][][Data][Cr]

Data 00 to 64: Sharpness 0 to 100

Acknowledgement

[k][][Set ID][][OK/NG][Data][x]

09. Color (Command: k i)

To adjust the screen color.

* This function is available only in AV/Component input.

Transmission

[k][i][][Set ID][][Data][Cr]

Data 00 to 64: Color 0 to 100

Acknowledgement

[i][][Set ID][][OK/NG][Data][x]

10. Tint (Command: k j)

To adjust the screen tint.

* This function is available only in AV/Component input.

Transmission

[k][j][][Set ID][][Data][Cr]

Data 00 to 64: Tint R50 to G50

Acknowledgement

[j][][Set ID][][OK/NG][Data][x]

11. Color Temperature (Command: x u)

To adjust the screen Color Temperature.

Transmission

[x][u][][Set ID][][Data][Cr]

Data 00 to 64: Warm 50 to Cool 50

Acknowledgement

[u][][Set ID][][OK/NG][Data][x]

12. H Position (Command: f q)

To adjust the screen Horizontal Position.

* This function is available only when the Tile Mode is set to Off.

* The operational range varies depending on the RGB input resolution.

(Only available for RGB-PC input.)

Transmission

[f][q][][Set ID][][Data][Cr]

Data 00 to 64: min. -50 (Left) to max. 50 (Right)

Acknowledgement

[q][][Set ID][][OK/NG][Data][x]

13. V Position (Command: f r)

To adjust the screen Vertical Position.

* This function is available only when the Tile Mode is set to Off.

* The operational range varies depending on the RGB input resolution.

(Only available for RGB-PC input.)

Transmission

[f][r][][Set ID][][Data][Cr]

Data 00 to 64: min. -50 (Bottom) to max. 50 (Top)

Acknowledgement

[r][][Set ID][][OK/NG][Data][x]

14. H Size (Command: f s)

To adjust the screen Horizontal Size.

* This function is available only when the Tile Mode is set to Off.

* The operational range varies depending on the RGB input resolution.

(Only available for RGB-PC input.)

Transmission

[f][s][][Set ID][][Data][Cr]

Data 00 - 64: Min. -50 (Reduce) - Max. 50 (Expand)

Acknowledgement

[s][][Set ID][][OK/NG][Data][x]

15. Auto Configuration (Command: j u)

To adjust the picture position and minimize image shaking automatically.

(Only available for RGB-PC input.)

Transmission

[j][u][][Set ID][][Data][Cr]

Data 01 : Set

Acknowledgement

[u][][Set ID][][OK/NG][Data][x]

16. Balance (Command: k t)

To adjust the sound balance.

Transmission

[k][t][][Set ID][][Data][Cr]

Data 00 to 64: Left 50 to Right 50

Acknowledgement

[t][][Set ID][][OK/NG][Data][x]

17. Sound Mode (Command: d y)

To select the Sound Mode.

Transmission

[d][y][][Set ID][][Data][Cr]

Data 01: Standard

02: Music

03: Cinema

04: Sport

05: Game

Acknowledgement

[y][][Set ID][][OK/NG][Data][x]

18. Treble (Command: k r)

To adjust the Treble values.

Transmission

[k][r][][Set ID][][Data][Cr]

Data 00 to 64: Treble 0 to 100

Acknowledgement

[r][][Set ID][][OK/NG][Data][x]

19. Bass (Command: k s)

To adjust the Bass values.

Transmission

[k][s][][Set ID][][Data][Cr]

Data 00 to 64: Bass 0 to 100

Acknowledgement

[s][][Set ID][][OK/NG][Data][x]

22. Volume Control (Command: k f)

To set the playback volume.

Transmission

[k][f][][Set ID][][Data][Cr]

Data 00 to 64: Volume 0 to 100

Acknowledgement

[f][][Set ID][][OK/NG][Data][x]

20. Speaker (Command: d v)

To select the speaker on/off.

Transmission

[d][v][][Set ID][][Data][Cr]

Data 00: Off

01: On

Acknowledgement

[v][][Set ID][][OK/NG][Data][x]

23. Time 1 (Year/ Month/ Day) (Command: f a)

To set the Time 1 (Year/ Month/ Day) values.

Transmission

[f][a][][Set ID][][Data1][][Data2][][Data3][Cr]

Data 1 00 to 14: 2010 to 2030

Data 2 01 to 0C: January to December

Data 3 01 to 1F: 1 to 31

* Enter "fa [Set ID] ff" for checking Time 1 (Year/ Month/ Day) values.

Acknowledgement

[a][][Set ID][][OK/NG][Data1][Data2][Data3][x]

21. Volume Mute (Command: k e)

To control the Volume Mute on/off.

Transmission

[k][e][][Set ID][][Data][Cr]

Data 00 : Mute (Volume Off)

01 : Current volume (Volume On)

Acknowledgement

[e][][Set ID][][OK/NG][Data][x]

24. Time 2 (Hour/ Minute/ Second) (Command: f x)

To set the Time 2 (Hour/ Minute/ Second) values.

Transmission

[f][x][][Set ID][][Data1][][Data2][][Data3][Cr]

Data1 00 to 17: 00 to 23 hours

Data2 00 to 3B: 00 to 59 minutes

Data3 00 to 3B: 00 to 59 seconds

* Enter "fx [Set ID] ff" for checking Time 2 (Hour/ Minute/ Second) values.

** This command won't work if Time 1 (Year/ Month/ Day) has not been set in advance.

Acknowledgement

[x][][Set ID][][OK/NG][Data1][Data2][Data3][x]

25. Off Timer(Repeat Mode/ Time) (Command: f e)

To set the Off Timer(Repeat Mode/ Time) function.

Transmission

[f][e][][Set ID][][Data1][][Data2][][Data3][Cr]

Data1

1. f1h to f7h (Read data)

F1: Read the 1st Off Time data

F2: Read the 2nd Off Time data

F3: Read the 3rd Off Time data

F4: Read the 4th Off Time data

F5: Read the 5th Off Time data

F6: Read the 6th Off Time data

F7: Read the 7th Off Time data

2. e1h-e7h (Delete one index), e0h (Delete all indexes)

E0: Delete all Off Time data

E1: Delete the 1st Off Time data

E2: Delete the 2nd Off Time data

E3: Delete the 3rd Off Time data

E4: Delete the 4th Off Time data

E5: Delete the 5th Off Time data

E6: Delete the 6th Off Time data

E7: Delete the 7th Off Time data

3. 01h to 06h (Set the day of week for Off Time)

00: Off

01: Once

02: Daily

03: Monday to Friday

04: Monday to Saturday

05: Saturday to Sunday

06: Sunday

07: Monday

08: Tuesday

09: Wednesday

0A: Thursday

0B: Friday

0C: Saturday

Data2 00 to 17: 00 to 23 Hours

Data3 00 to 3B: 00 to 59 Minutes

* To read or delete the Off Time list, set FFH for [Data2] and [Data3].

(Example 1: fe 01 f1 ff ff - Read the 1st Off Time data.)

(Example 2: fe 01 e1 ff ff - Delete the 1st Off Time data.)

(Example 3: fe 01 04 02 03 - Set the Off Time to "Monday to Saturday, 02:03".)

* This function is supported only when 1 (Year/Month/Day) and 2 (Hour/Minute/Second) are set.

Acknowledgement

[e][][Set ID][][OK/NG][Data1][Data2][Data3][x]

26. On Timer(Repeat Mode/ Time) (Command: f d)

To set the On Timer(Repeat mode/ Time) function.

Transmission

[f][d][][Set ID][][Data1][][Data2][][Data3][Cr]

Data1

1. f1h to f7h (Read data)

F1: Read the 1st On Time data

F2: Read the 2nd On Time data

F3: Read the 3rd On Time data

F4: Read the 4th On Time data

F5: Read the 5th On Time data

F6: Read the 6th On Time data

F7: Read the 7th On Time data

2. e1h-e7h (Delete one index), e0h (Delete all indexes)

E0: Delete all On Time data

E1: Delete the 1st On Time data

E2: Delete the 2nd On Time data

E3: Delete the 3rd On Time data

E4: Delete the 4th On Time data

E5: Delete the 5th On Time data

E6: Delete the 6th On Time data

E7: Delete the 7th On Time data

3. 01h to 06h (Set the day of week for On Time)

00: Off

01: Once

02: Daily

03: Monday to Friday

04: Monday to Saturday

05: Saturday to Sunday

06: Sunday

07: Monday

08: Tuesday

09: Wednesday

0A: Thursday

0B: Friday

0C: Saturday

Data2 00 to 17: 00 to 23 Hours

Data3 00 to 3B: 00 to 59 Minutes

* To read or delete the Off Time list, set FFH for [Data2] and [Data3].

(Example 1: fd 01 f1 ff ff - Read the 1st On Time data.)

(Example 2: fd 01 e1 ff ff - Delete the 1st On Time data.)

(Example 3: fd 01 04 02 03 - Set the On Time to "Monday to Saturday, 02:03".)

* This function is supported only when 1 (Year/Month/Day) and 2 (Hour/Minute/Second) are set.

Acknowledgement

[d][][Set ID][][OK/NG][Data1][Data2][Data3][x]

27. On Timer Input (Command: f u)

To select an external input for the current On Time setting and add a new schedule or change the existing schedule.

Transmission

[f][u][][Set ID][][Data1][Cr]

[f][u][][Set ID][][Data1][Data2][Cr]

Data (Add schedule)

20: Input (AV)

40: Component

60: RGB

70: DVI-D

90: HDMI (HDMI1)

C0: Display Port

91: HDMI2/SDI

B0: SuperSign

Data1 (Change schedule)

1. f1h to f4h (Read data)

F1: Select the 1st schedule input

F2: Select the 2nd schedule input

F3: Select the 3rd schedule input

F4: Select the 4th schedule input

F5: Select the 5th schedule input

F6: Select the 6th schedule input

F7: Select the 7th schedule input

Data2

20: Input (AV)

40: Component

60: RGB

70: DVI-D

90: HDMI (HDMI1)

C0: Display Port

91: HDMI2/SDI

B0: SuperSign

* To read the schedule input, enter FFH for [Data2].

If no schedule is available for [Data1] when attempting to read or change the schedule data, the text NG will be displayed and the operation fails.

(Example 1: fu 01 60 - Move each schedule input down one row and save the 1st schedule input in RGB mode.)

(Example 2: fu 01 f1 ff - Read the 1st schedule input.)

(Example 3: fu 01 f3 20 - Change the 3rd data schedule input to the current On Time and AV input. If there is no third schedule, the text NG will be displayed and the operation fails.)

* This function is supported only when Time 1 (Year/Month/Day), Time 2 (Hour/Minute/Second), On Time (Repeat Mode/Time) are set.

** It may not be supported depending on the model.

Acknowledgement

[u][][Set ID][][OK/NG][Data][x]

[u][][Set ID][][OK/NG][Data1][Data2][x]

28. Sleep Time (Command: f f)

To set the Sleep Time.

Transmission

[f][f][][Set ID][][Data][Cr]

Data 00: Off (Sleep Timer off)

01: 10 min.

02: 20 min.

03: 30 min.

04: 60 min.

05: 90 min.

06: 120 min.

07: 180 min.

08: 240 min.

Acknowledgement

[f][][Set ID][][OK/NG][Data][x]

29. Power On Delay (Command: f h)

To set the schedule delay when the power is turned on. (Unit: Second)

Transmission

[f][h][][Set ID][][Data][Cr]

Data 00 to 64: min. 0 to max. 100 (sec.)

Acknowledgement

[h][][Set ID][][OK/NG][Data][x]

30. Automatic Standby (Command: m n)

To set the Automatic Standby function.

Transmission

[m][n][][Set ID][][Data][Cr]

Data 00: Off (No off after 4 hours)

01: 4 Hours (Off after 4 hours)

Acknowledgement

[n][][Set ID][][OK/NG][Data][x]

31. Auto Off (Command: f g)

To set the Auto Off function.

Transmission

[f][g][][Set ID][][Data][Cr]

Data 00: Off (No off after 15 minutes)
01: 15 min.(Off after 15 minutes)

Acknowledgement

[g][][Set ID][][OK/NG][Data][x]

32. Language (Command: f i)

To set the language for OSD.

Transmission

[f][i][][Set ID][][Data][Cr]

Data 00: Czech
01: Danish
02: German
03: English
04: Spanish (EU)
05: Greek
06: French
07: Italian
08: Dutch
09: Norwegian
0A: Portuguese
0B: Portuguese (BR)
0C: Russian
0D: Finnish
0E: Swedish
0F: Korean
10: Chinese (Mandarin)
11: Japanese
12: Yue Chinese (Cantonese)

Acknowledgement

[i][][Set ID][][OK/NG][Data][x]

33. Power Indicator (Standby Light) (Command: f o)

To set the Power Indicator (Standby Light) function.

Transmission

[f][o][][Set ID][][Data][Cr]

Data 00: Off
01: On

** It may not be supported depending on the model.

Acknowledgement

[o][][Set ID][][OK/NG][Data][x]

34. Power Indicator (Power Light) (Command: f p)

To set the Power Indicator (Power Light) function.

Transmission

[f][p][][Set ID][][Data][Cr]

Data 00: Off
01: On

** It may not be supported depending on the model.

Acknowledgement

[p][][Set ID][][OK/NG][Data][x]

35. ISM mode (Command: j p)

To select ISM method for avoiding having a fixed image remain on screen.

Transmission

[j][p][][Set ID][][Data][Cr]

Data 01: Inversion
02: Orbiter
04: White Wash
08. Normal

Acknowledgement

[p][][Set ID][][OK/NG][Data][x]

36. Fail Over Select (Command: m i)

To set the Fail Over function.

Transmission

[m][i][][Set ID][][Data][Cr]

Data 00: Off
01: Auto
02: Manual

Acknowledgement

[i][][Set ID][][OK/NG][Data][x]

37. Fail Over Input Select (Command: m j)

To select the input source for auto switch.

* This command is only available when the fail over (auto) mode is set to Custom.

Transmission

```
[m][j][ ][Set ID][ ][Data1][ ][Data2][ ][Data3][Cr]
[ ][Data4][ ][Data5][Cr]
```

Data 1 to 5 (Priority 1 to 5)

60: RGB
70: DVI-D
90: HDMI(HDMI1)
C0: Display Port
91: HDMI2/SDI

* The number of data items differs depending on the model.

Acknowledgement

```
[j][ ][SetID][ ][OK/NG][Data1][Data2][Data3][Data4]
[ ][Data5][x]
```

Data 1 to 5 (Priority 1 to 5)

60: RGB
70: DVI-D
90: HDMI(HDMI1)
C0: Display Port
91: HDMI2/SDI

* The number of data items differs depending on the model.

38. Reset (Command: f k)

To execute the Picture, Screen, Audio and Factory reset function.

(Screen Reset can only be performed in RGB input mode.)

Transmission

```
[f][k][ ][Set ID][ ][Data][Cr]
```

Data 00: Picture Reset

01: Screen Reset
02: Factory Reset
03: Audio Reset

Acknowledgement

```
[k][ ][Set ID][ ][OK/NG][Data][x]
```

39. Tile Mode (Command: d d)

To set a Tile Mode and Tile Column/ Row values.

Transmission

```
[d][d][ ][Set ID][ ][Data][Cr]
```

Data 00 to FF: 1st byte - Tile Row
2nd byte - Tile Column

*00, 01, 10, 11 means Tile Mode Off.

** It may not be supported depending on the model.

Acknowledgement

```
[d][ ][Set ID][ ][OK/NG][Data][x]
```

40. Tile Mode Check (Command: d z)

To check Tile Mode status.

Transmission

```
[d][z][ ][Set ID][ ][Data][Cr]
```

Data FF: Check Tile Mode status.

** It may not be supported depending on the model.

Acknowledgement

```
[z][ ][Set ID][ ][OK/NG][Data1][Data2][Data3][x]
```

Data1 00: Tile Mode Off

01: Tile Mode On

Data2 00 to 0F: Tile Row

Data3 00 to 0F: Tile Column

41. Tile ID (Command: d i)

To set Tile ID.

Transmission

```
[d][i][ ][Set ID][ ][Data][Cr]
```

Data 01 to E1: Tile ID 01 to 225**

FF: Check Tile ID

** Data could not be set over (Tile Column) x (Tile Row).

** It may not be supported depending on the model.

Acknowledgement

```
[i][ ][Set ID][ ][OK/NG][Data][x]
```

*NG will be return if data is over (Tile Column) x (Tile Row), except 0xFF.

42. Tile H Position (Command: d e)

To adjust the Tile Horizontal position.

* This function is available only when the Natural option of the Tile Mode is set to Off while the Tile Mode set to On.

Transmission

```
[d][e][ ][Set ID][ ][Data][Cr]
```

Data 00 to 32: -50 (Left) to 0 (Right)

*Left/Right values depend on Tile H size.

** It may not be supported depending on the model.

Acknowledgement

```
[e][ ][Set ID][ ][OK/NG][Data][x]
```

43. Tile V Position (Command: d f)

To adjust the Tile Vertical position.

* This function is available only when the Natural option of the Tile Mode is set to Off while the Tile Mode set to On.

Transmission

[d][f][][Set ID][][Data][Cr]

Data 0 to 32: 0 (Bottom) to 50 (Top)

* Bottom/Top values depend on Tile Vertical size.

** It may not be supported depending on the model.

Acknowledgement

[f][][Set ID][][OK/NG][Data][x]

44. Tile H Size (Command: d g)

To adjust the Tile Horizontal Size.

*Set Tile H Position to 0x32 before setting Tile H Size.

* This function is available only when the Natural option of the Tile Mode is set to Off while the Tile Mode set to On.

Transmission

[d][g][][Set ID][][Data][Cr]

Data 00 to 32: 0 to 50

** It may not be supported depending on the model.

Acknowledgement

[g][][Set ID][][OK/NG][Data][x]

45. Tile V Size (Command: d h)

To adjust the Tile Vertical size.

*Set Tile V Position to 0x00 before setting Tile V Size.

* This function is available only when the Natural option of the Tile Mode is set to Off while the Tile Mode set to On.

Transmission

[d][h][][Set ID][][Data][Cr]

Data 00 to 32: 0 to 50

** It may not be supported depending on the model.

Acknowledgement

[h][][Set ID][][OK/NG][Data][x]

46. Natural Mode (In Tile Mode) (Command : d j)

To display the image naturally, the part of the image that would normally be displayed in the gap between the monitors is omitted.

Transmission

[d][j][][Set ID][][Data][Cr]

Data 00: Off

01: On

Acknowledgement

[j][][Set ID][][OK/NG][Data][x]

47. DPM Select (Command: f j)

To set the DPM (Display Power Management) function.

Transmission

[f][j][][Set ID][][Data][Cr]

Data 00: Off

01: On

* Data settings may vary depending on your model as below.

Data 00: Off

01: 5 sec.

02: 10 sec.

03: 15 sec.

04: 1 min.

05: 3 min.

06: 5 min.

07: 10 min.

Acknowledgement

[j][][Set ID][][OK/NG][Data][x]

48. FAN Control (Command : d o)

To set the Fan mode.

Transmission

[d][o][][Set ID][][Data][Cr]

Data 00: Auto

01: On

02: Manual

03: Off

** It may not be supported depending on the model.

Acknowledgement

[o][][Set ID][][OK/NG][Data][x]

49. FAN Fault Check (Command: d w)

To check the fan errors.

Transmission

[d][w][][Set ID][][Data][Cr]

Data FF: Read the status

Acknowledgement

[w][][Set ID][][OK/NG][Data][x]

Data 00: Fan fault
01: Fan OK
02: Model without a Fan

For 72WX70MF, see the following.

[w][][Set ID][][OK/NG][Data1][Data2][x]

Data1 00: One or more fans are faulty.
01: All fans are OK.
02: The model has no fan.

Data2 00: No fan is faulty (all fans are OK).
01: 1 fan is faulty.
02: 2 fans are faulty.
03: 3 fans are faulty.
04: 4 fans are faulty.
05: 5 fans are faulty.
06: 6 fans are faulty.

50. Temperature Value (Command: d n)

To check the inside temperature value.

Transmission

[d][n][][Set ID][][Data][Cr]

Data FF: Check the status

Acknowledgement

[n][][Set ID][][OK/NG][Data][x]

[n][][Set ID][][OK/NG][Data1][Data2][Data3][x]

* Temperature is displayed in hexadecimal.
Up to Data3 are provided as 72WX70MF has 3 temperature sensors.

Data1: Temperature sensor at the exit (top).
Data2: Temperature sensor at the entrance (bottom).
Data3: Temperature sensor at the main board (main PCB).

51. Remote Controller Lock/ Key Lock (Command: k m)

When the remote control and front keys are locked in standby mode, the power cannot be turned on using the remote control or front power button.

Transmission

[k][m][][Set ID][][Data][Cr]

Data 00: Off (Lock Off)
01: On (Lock On)

* Display will not be turned on by power on key of remote controller and front panel control keys, if key is locked on in standby mode.

Acknowledgement

[m][][Set ID][][OK/NG][Data][x]

** It may not be supported depending on the model.

52. Key (Command: m c)

To send a key code of the IR remote control.

Transmission

[m][c][][Set ID][][Data][Cr]

Data IR_KEY_CODE

Acknowledgement

[c][][Set ID][][OK/NG][Data][x]

For a key code, see the IR Code.

* Some key codes are not supported depending on the model.

53. OSD Select (Command: k l)

To select OSD(On Screen Display) on/off.

Transmission

[k][l][][Set ID][][Data][Cr]

Data 00: Off
01: On

Acknowledgement

[l][][Set ID][][OK/NG][Data][x]

54. Elapsed time return (Command: d l)

To check the panel used time.

Transmission

[d][l][][Set ID][][Data][Cr]

Data FF: Read the status

Acknowledgement

[l][][Set ID][][OK/NG][Data][x]

* Returned data means used hours in hexadecimal.

57. White Balance Red Gain (Command: j m)

To set the White Balance Red Gain.

Transmission

[j][m][][Set ID][][Data][Cr]

Data 00 to FE: Red Gain 0 to 254

Acknowledgement

[m][][Set ID][][OK/NG][Data][x]

55. Serial No.Check (Command: f y)

To check the Serial Numbers.

Transmission

[f][y][][Set ID][][Data][Cr]

Data FF: Check the product Serial Number

Acknowledgement

[y][][Set ID][][OK/NG][Data][x]

* Data is ASCII code.

58. White Balance Green Gain (Command: j n)

To set the White Balance Green Gain.

Transmission

[j][n][][Set ID][][Data][Cr]

Data 00 to FE: Green Gain 0 to 254

Acknowledgement

[n][][Set ID][][OK/NG][Data][x]

56. S/W Version (Command: f z)

To check the Software Version.

Transmission

[f][z][][Set ID][][Data][Cr]

Data FF: Check the Software version

Acknowledgement

[z][][Set ID][][OK/NG][Data][x]

59. White Balance Blue Gain (Command: j o)

To set the White Balance Blue Gain.

Transmission

[j][o][][Set ID][][Data][Cr]

Data 00 to FE: Blue Gain 0 to 254

Acknowledgement

[o][][Set ID][][OK/NG][Data][x]

60. Backlight (Command: m g)

To adjust the screen backlight.

Transmission

[m][g][][Set ID][][Data][Cr]

Data 00 to 64: Backlight 0 to 100

Acknowledgement

[g][][Set ID][][OK/NG][Data][x]

** It may not be supported depending on the model.

61. PC Power Control (Command: d t)

To control the PC power if the PC and the monitor are synchronized.

Transmission

[d][t][][Set ID][][Data][Cr]

Data

00: Synchronized (When the monitor is off, the PC is also turned off.)

01: Not synchronized (The monitor is off but the PC is on.)

** It may not be supported depending on the model.

Acknowledgement

[t][][Set ID][][OK][Data][x]

Data

00: Synchronized (When the monitor is off, the PC is also turned off.)

01: Not synchronized (The monitor is off but the PC is on.)

62. PC Power (Command: d s)

Control the PC power.

Transmission

[d][s][][Set ID][][Data][Cr]

Data 00: PC is turned off.

01: PC is turned on.

** It may not be supported depending on the model.

Acknowledgement

[s][][Set ID][][OK][Data][x]

Data 00: PC is turned off.

01: PC is turned on.

63. Reading luminance values (Command: m u)

Reads luminance values.

Transmission

[m][u][][Set ID][][FF][Cr]

Acknowledgement

[u][][Set ID][][OK/NG][Data1][Data2][Data3][Data4][Data5][Data6][Data7][x]

Data1 00-64 backlight 0-100

Data2 00-ff: Upper 2-byte of CA210 measured value

Data3 00-ff: Lower 2-byte of CA210 measured value
CA210 measured value Hex: 0000-ffff, Decimal: 0 - 65535

Data4 00-ff: Upper 2-byte of BLU measured value

Data5 00-ff: Lower 2-byte of BLU measured value

Data6 00-ff: Upper 2 bytes of BLU No. 2 sensor measured value

Data7 00-ff: Lower 2 bytes of BLU No. 2 sensor measured value

BLU measured value Hex: 0000-ffff, Decimal: 0 - 65535

* CA210 measured value is entered through the calibration procedure during final assembly. Default value is 0 before calibration.

** It may not be supported, depending on the model.

64. Status check (Command: s v)

Check various statuses.

Transmission

[s][v][][Set ID][][Data][][FF][Cr]

Data 05: Check the normal operation of No.1 and No.2 luminance sensors.

06: luminance sensor being used:

07: Check the normal operation of top, bottom, or main temperature sensors.

Acknowledgement

[v][][Set ID][][OK/NG][Data][Data1][x]

When the Data is 05

Data1 00: All normal

01: BLU sensor 1 normal, BLU sensor 2 fail

02: BLU sensor 1 fail, BLU sensor 2 normal

03: All fail

When the Data is 06

Data1 00: No.1 luminance sensor is being used

01: No.2 luminance sensor is being used

When the Data is 07

Data1 00: All temperature sensors fail

01: Top normal, Bottom fail, Main fail

02: Top fail, Bottom normal, Main fail

03: Top normal, Bottom normal, Main fail

04: Top fail, Bottom fail, Main normal

05: Top normal, Bottom fail, Main fail

06: Top fail, Bottom normal, Main fail

07: All temperature sensors normal

When the Data is 08

Acknowledgement

[v][][SetID][][OK/NG][Data][Data1][Data2][Data3][x]

Data1: Temperature of the top sensor area when the set is powered off.

Data2: Temperature of the bottom sensor area when the set is powered off.

Data3: Temperature of the main sensor area when the set is powered off.

When the Data is 09

Acknowledgement

[v][][SetID][][OK/NG][Data][Data1][Data2][x]

Data1 00-ff: Upper 2-byte of Fan Speed

Data2 00-ff: Lower 2-byte of Fan Speed

Fan Speed: Hex 0-20D0, Decimal 0-8400

** It may not be supported, depending on the model.

65. BLU Maintenance (Command: m t)

Select ON/OFF of BLU Maintenance.

Transmission

[m][t][][Set ID][][Data][Cr]

Data 00: BLU Maintenance OFF

01: BLU Maintenance ON

** It may not be supported, depending on the model.

Acknowledgement

[t][][Set ID][][OK/NG][Data][x]

66. Mirror mode (Command: t a)

Sets the Mirror mode to Off/On/Auto.

Transmission

[t][a][][Set ID][][Data][Cr]

Data 00: Mirror mode OFF

01: Mirror mode ON

02: Mirror mode Auto

** It may not be supported, depending on the model.

Acknowledgement

[a][][Set ID][][OK/NG][Data][x]



Make sure to read the Safety Precautions before using the product.
Keep the Owner's Manual(CD) in an accessible place for future reference.
The model and serial number of the SET is located on the back and one side of the SET.
Record it below should you ever need service.

MODEL _____

SERIAL _____

To obtain the source code under GPL, LGPL, MPL and other open source licenses, that is contained in this product, please visit <http://opensource.lge.com>.

In addition to the source code, all referred license terms, warranty disclaimers and copyright notices are available for download. LG Electronics will also provide open source code to you on CD-ROM for a charge covering the cost of performing such distribution (such as the cost of media, shipping and handling) upon email request to opensource@lge.com. This offer is valid for three (3) years from the date on which you purchased the product.

WARNING -This is a class A product. In a domestic environment this product may cause radio interference in which case the user may be required to take adequate measures.

Temporary noise is normal when powering ON or OFF this device.